

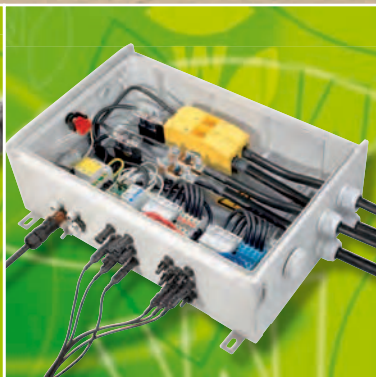

**gesis**<sup>®</sup> SOLAR  
Electrical Installation Technology  
for Photovoltaics  
Catalog 2013







**Our Service  
Hotline SOLAR:**

The **gesis**<sup>®</sup> RAN solar distribution units are configured for your project and delivered on time and ready for installation. Ask our experts!

**Phone: +49-9 51 93 24-972**



**ACDC**  
Pluggable  
**SOLAR**  
Connector System







## Intro

### AC/DC-SOLAR

A solution for everything

Page

4-5



## PST 40i1

### DC-SOLAR Products

#### PST40i1

- Cable assemblies 9
- Connectors 10-13
- Accessories 14-15

6-15

9  
10-13  
14-15

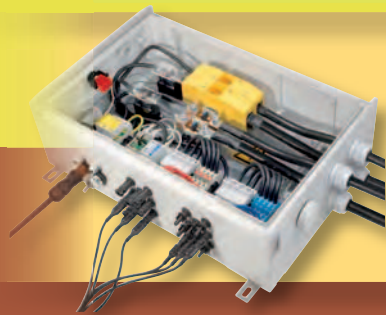

## Distribution Units DC-SOLAR AC-SOLAR

Solar AC and DC distribution units for your project

- Planning **gesis** RAN SOLAR 18-19
- Solutions for the combiner box 20-21
- Overvoltage protection **wietap** 22-31
- VPN industrial router **wienet** 32-35
- DIN rail terminal blocks **selos** 36-47

16-17  
18-19  
20-21  
22-31  
32-35  
36-47



## RST 25i3 RST 25i5

### AC-SOLAR Products

#### RST 25i3 / RST 25i5

- Connectors, cable assemblies **RST 25i3** 48-53
- Connectors, cable assemblies **RST 25i5** 54-59
- Technical Data 60-63

48-63  
48-53  
54-59  
60-63



## RST 50i5

### AC-SOLAR Products

#### RST 50i5

- Connectors 66-67
- Technical Data 68-69
- Accessories 70-71

64-71  
66-67  
68-69  
70-71



## Support Information Data

### Support and Information

- Description of flammability classes 72
- Description of weathering resistance 73

72-79

### Part number index

74-77



# A solution for everything

## Efficiency in all fields of photovoltaics

The Wieland Group with almost 2,000 staff members is one of the leading companies worldwide in the field of electrical connection technology. Environmental protection and preservation of natural resources are major company goals for Wieland.

Environmental protection and electrical contacts are a perfect match in the field of photovoltaics (PV): the sun is an inexhaustible energy source – Wieland's photovoltaic connectors harness this energy sustainably and efficiently.

### The AC solar system

With its 3 and 5 pole connector system RST25i3/i5 Wieland offers the optimal solution for connectivity on the AC side. Pre-assembled components and the IP 65/67 protection degree enable a fast and safe installation even under adverse conditions. The RST system includes field assembly connectors, pre-assembled connectors and cordsets, and also device connectors, to be used for example on inverters and distribution panels. Leading manufacturers equip their products with these connectors in their factories. Furthermore pre-assembled distribution panels and combiner boxes are part of our product range. Inverters are often installed in groups, often with the same distance between them. On the AC side, installation is performed in a similar way which has long been the case in module-to-module connections (DC). Using the gesis products installation times and logistics are reduced to a minimum.

### The DC solar system

The PST40i1 photovoltaic connectors from Wieland Electric for the connection of PV modules and inverters are safe, easy to install environmentally sealed, and require a tool for disconnect. This was confirmed by an extensive test performed at an independent laboratory for the photovoltaic magazine "Photon". The laboratory test not only certified that the PV connectors have a top position among the tested connectors, but that the connectors also were one of the winners among the single-pole, latchable solar connectors (also see: "Photon" 09/2009).

Its IP68 protection degree, the robust design as well as the TÜV-tested compatibility with competitive products enable flexible use.

With conductor cross sections from 4 mm<sup>2</sup> to 10.0 mm<sup>2</sup> even long distances to the inverter can be implemented pluggably and efficiently.

### Wieland photovoltaics – pluggable from the module to the power connection

With Wieland, the enormous benefits of a pluggable electrical installation are no longer restricted to the DC side of photovoltaic systems.

Whether for main power supply connections (AC) or connectors for the drives of tracking systems, durable electrical connectors are the backbone of a profitable installation.





The solar product range from Wieland offers an efficient connectivity solution for all electrical termination points, in solar systems of every size as is.

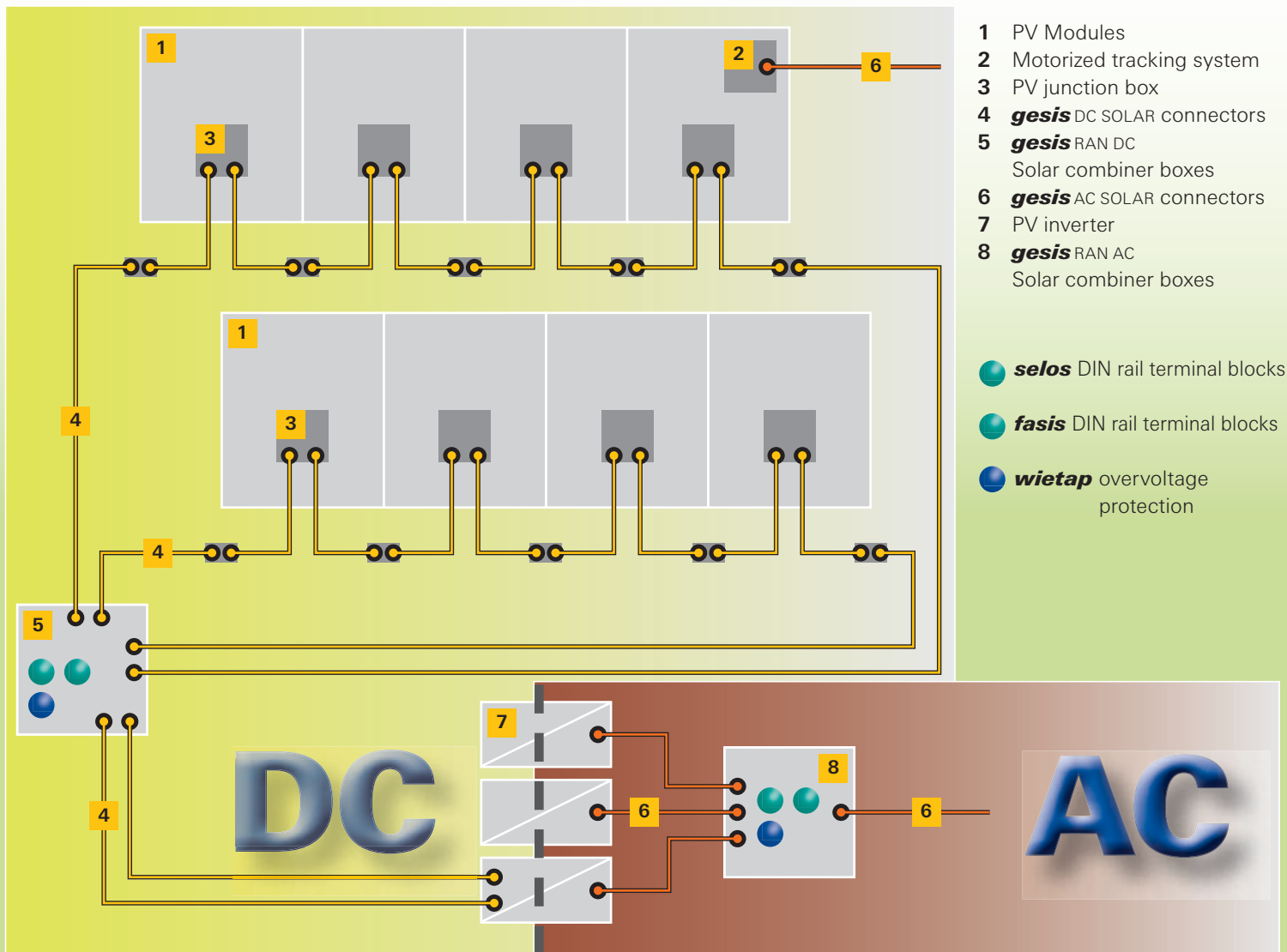





# DC-Solar applications – Connectors for photovoltaic systems

## Application example

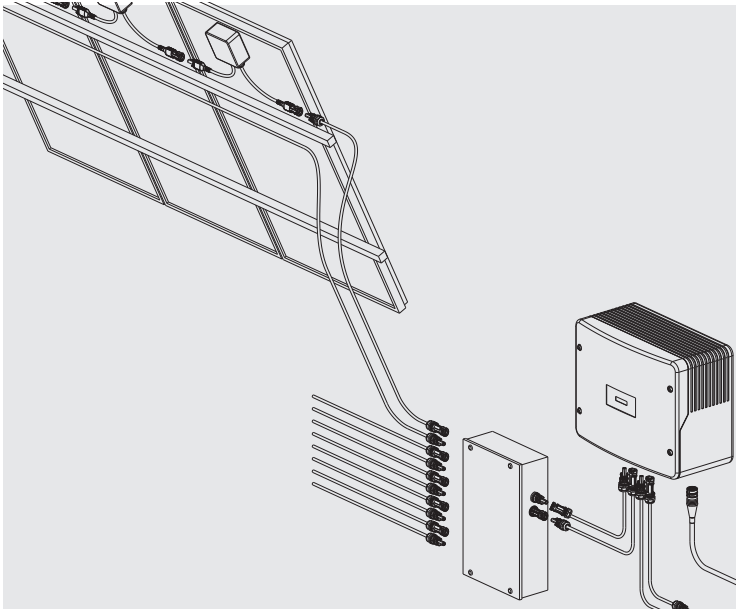

## General

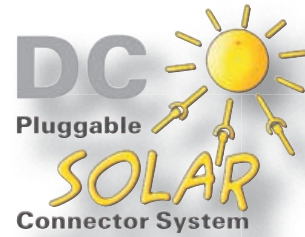



## Features:

- Easy installation with only a few components
- Overmolded cable assemblies, crimp contact field-assembled connectors, and also bulkhead mount device connectors
- Field assembly crimp contacts are removable from the housings
- Mate-compatible with competitive standard products
- High IP protection IP68 (3 m, 2 h)
- For 4.0 / 6.0 / 10.0 mm<sup>2</sup> cross sections
- High current-carrying capability up to 40 A  
32 A at 4.0 mm<sup>2</sup>;  
40 A at 6.0 mm<sup>2</sup> and 10.0 mm<sup>2</sup>  
-> unaffected by derating curve up to 85 °C
- Very low contact resistance of  
< 0.15 mOhm (typ.) with solid, turned brass contacts  
with silver plating
- Turned contacts mean that positioning is not required



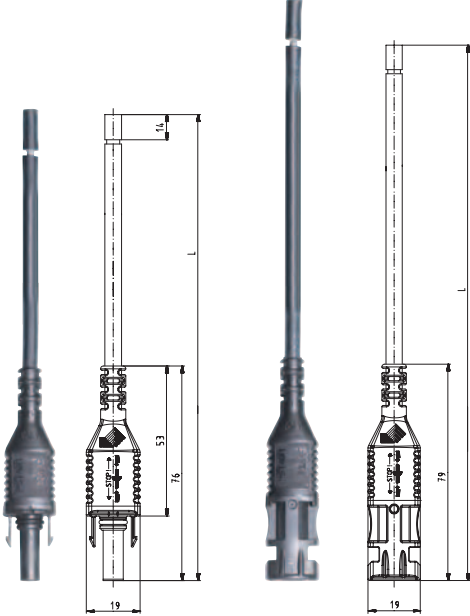

# Cable assemblies 2.5 – 10.0 mm<sup>2</sup> for installers and manufacturers of solar modules

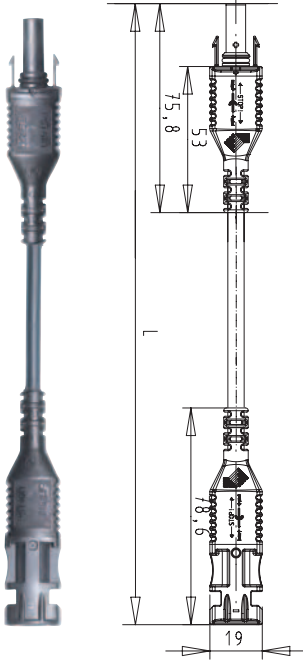
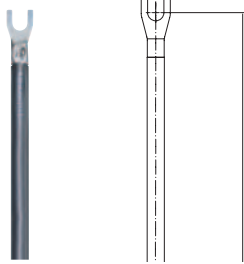
<p><b>TECSUN PV1-F</b></p>  <p>Pre-assembled <b>Photon</b> www.photon-international.com Total grade 1.7 Best in class (09/2010)</p>	 <p><b>Female – Free end / Male – Free end (cable pair)</b></p> <p>Connection cable</p> <p>Wire ends insulation partly stripped</p> <p>Insul. strip length 14 mm</p>	<p><b>TECSUN PV1-F</b></p>  <p>Pre-assembled <b>Photon</b> www.photon-international.com Total grade 1.7 Best in class (09/2010)</p>	 <p><b>Female – Male</b></p> <p>Extension cable</p> <p>Locking device yes</p>																																										
<p>Color Length m<sup>1)</sup></p> <p>black 1.2 1.3 1.4 1.5 1.6 1.7 1.8 1.9 2.0 2.1 2.2 2.3 2.4</p> <p><sup>1)</sup> Total length of Male – Free End and Female – Free End each</p>	<p>Part No.</p> <p><b>For cable cross section:</b></p> <table border="1"> <thead> <tr> <th>2.5 mm<sup>2</sup></th> <th>4.0 mm<sup>2</sup></th> <th>6.0 mm<sup>2</sup></th> </tr> </thead> <tbody> <tr><td>96.311.1209.1</td><td>96.312.1209.1</td><td>96.313.1209.1</td></tr> <tr><td>96.311.1309.1</td><td>96.312.1309.1</td><td>96.313.1309.1</td></tr> <tr><td>96.311.1409.1</td><td>96.312.1409.1</td><td>96.313.1409.1</td></tr> <tr><td>96.311.1509.1</td><td>96.312.1509.1</td><td>96.313.1509.1</td></tr> <tr><td>96.311.1609.1</td><td>96.312.1609.1</td><td>96.313.1609.1</td></tr> <tr><td>96.311.1709.1</td><td>96.312.1709.1</td><td>96.313.1709.1</td></tr> <tr><td>96.311.1809.1</td><td>96.312.1809.1</td><td>96.313.1809.1</td></tr> <tr><td>96.311.1909.1</td><td>96.312.1909.1</td><td>96.313.1909.1</td></tr> <tr><td>96.311.2009.1</td><td>96.312.2009.1</td><td>96.313.2009.1</td></tr> <tr><td>96.311.2109.1</td><td>96.312.2109.1</td><td>96.313.2109.1</td></tr> <tr><td>96.311.2209.1</td><td>96.312.2209.1</td><td>96.313.2209.1</td></tr> <tr><td>96.311.2309.1</td><td>96.312.2309.1</td><td>96.313.2309.1</td></tr> <tr><td>96.311.2409.1</td><td>96.312.2409.1</td><td>96.313.2409.1</td></tr> </tbody> </table>	2.5 mm <sup>2</sup>	4.0 mm <sup>2</sup>	6.0 mm <sup>2</sup>	96.311.1209.1	96.312.1209.1	96.313.1209.1	96.311.1309.1	96.312.1309.1	96.313.1309.1	96.311.1409.1	96.312.1409.1	96.313.1409.1	96.311.1509.1	96.312.1509.1	96.313.1509.1	96.311.1609.1	96.312.1609.1	96.313.1609.1	96.311.1709.1	96.312.1709.1	96.313.1709.1	96.311.1809.1	96.312.1809.1	96.313.1809.1	96.311.1909.1	96.312.1909.1	96.313.1909.1	96.311.2009.1	96.312.2009.1	96.313.2009.1	96.311.2109.1	96.312.2109.1	96.313.2109.1	96.311.2209.1	96.312.2209.1	96.313.2209.1	96.311.2309.1	96.312.2309.1	96.313.2309.1	96.311.2409.1	96.312.2409.1	96.313.2409.1	<p>Color Length m<sup>1)</sup></p> <p>black 1.0 2.0 3.0 4.0 5.0 6.0</p>	<p>Part No.</p> <p><b>For cable cross section:</b></p> <p><b>4.0 mm<sup>2</sup></b></p> <p>96.312.1000.1 96.312.2000.1 96.312.3000.1 96.312.4000.1 96.312.5000.1 96.312.6000.1</p> <p><b>For cable cross section:</b></p> <p><b>6.0 mm<sup>2</sup></b></p> <p>96.313.1000.1 96.313.2000.1 96.313.3000.1 96.313.4000.1 96.313.5000.1 96.313.6000.1</p>
2.5 mm <sup>2</sup>	4.0 mm <sup>2</sup>	6.0 mm <sup>2</sup>																																											
96.311.1209.1	96.312.1209.1	96.313.1209.1																																											
96.311.1309.1	96.312.1309.1	96.313.1309.1																																											
96.311.1409.1	96.312.1409.1	96.313.1409.1																																											
96.311.1509.1	96.312.1509.1	96.313.1509.1																																											
96.311.1609.1	96.312.1609.1	96.313.1609.1																																											
96.311.1709.1	96.312.1709.1	96.313.1709.1																																											
96.311.1809.1	96.312.1809.1	96.313.1809.1																																											
96.311.1909.1	96.312.1909.1	96.313.1909.1																																											
96.311.2009.1	96.312.2009.1	96.313.2009.1																																											
96.311.2109.1	96.312.2109.1	96.313.2109.1																																											
96.311.2209.1	96.312.2209.1	96.313.2209.1																																											
96.311.2309.1	96.312.2309.1	96.313.2309.1																																											
96.311.2409.1	96.312.2409.1	96.313.2409.1																																											
<p>The hole dimensions or diameters of the cable lugs are suitable for M5 screws.</p> <p>Std. Pack on request</p>	 <p><b>Spade lug</b></p> <p>Connection cable</p> <p>Wire ends Spade lug</p>	<p>black 1.0 2.0 3.0 4.0 5.0 6.0</p>	<p><b>For cable cross section:</b></p> <p><b>10.0 mm<sup>2</sup></b></p> <p>96.314.1000.1 96.314.2000.1 96.314.3000.1 96.314.4000.1 96.314.5000.1 96.314.6000.1</p>																																										
<p>Color Length m</p> <p>black</p>	<p>Part No.</p> <p><b>on request</b></p>																																												

In accordance with installation regulation IEC 60364-5-52 (DIN VDE 0100-522.3) cable systems must be designed such that ingress of water will not cause damage. To ensure that water drains off as quickly as possible, the cable lengths differ by 10cm. This ensures that the connection is not the lowest point.



## Connector housings Outer cable diameters of 4.0 – 8.0 mm



### Female Contact

#### Field-assembled connectors and device connectors

Crimp technology  
Contacts ordered separately

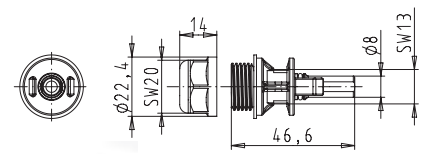
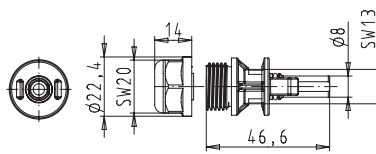
Assembly with customary flat wrench  
SW13 for housing and  
SW20 for gland



Approval	Outer cable diameter in mm	Color	Part No.	Std. Pack	Part No.	Std. Pack			
 TÜV certificate according to DIN V VDE V 0126-3/12.06 (EN 50521 being prepared) 	4 – 5	black	96.111.0153.1	100	<b>Device connector</b> 96.111.1053.1 100 96.111.1253.1 100	96.111.1053.1 100 96.111.1253.1 100			
		black	96.111.0053.1	100					
		black	96.111.0253.1	100					
	with touring protection								
	ETL certificate through Intertek according to - UL 486A-486B/486D - CAN/CSA-C22.2 No. 65-03/ No. 198.2-05 UL approval being prepared 	4 – 5	black	Y6.111.0153.1			100	Y6.111.1053.1 100 Y6.111.1253.1 100	Y6.111.1053.1 100 Y6.111.1253.1 100
		5 – 7	black	Y6.111.0053.1			100		
		7 – 8	black	Y6.111.0253.1	100				
	with touring protection								



### Male Connector

#### Field-assembled connectors and device connectors

Crimp technology  
Contacts ordered separately

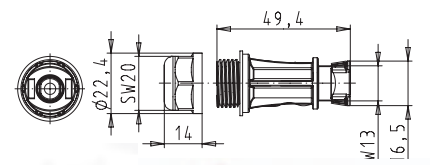
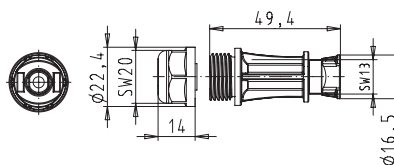
Assembly with customary flat wrench  
SW13 for housing and  
SW20 for gland



Approval	Outer cable diameter in mm	Color	Part No.	Std. Pack	Part No.	Std. Pack			
 TÜV certificate according to DIN V VDE V 0126-3/12.06 (EN 50521 being prepared) 	4 – 5	black	96.112.0153.1	100	<b>Device connector</b> 96.112.1053.1 100 96.111.1253.1 100	96.112.1053.1 100 96.111.1253.1 100			
		black	96.112.0053.1	100					
		black	96.112.0253.1	100					
	with touring protection								
	ETL certificate through Intertek according to - UL 486A-486B/486D - CAN/CSA-C22.2 No. 65-03/ No. 198.2-05 UL approval being prepared 	4 – 5	black	Y6.112.0153.1			100	Y6.112.1053.1 100 Y6.112.1253.1 100	Y6.112.1053.1 100 Y6.112.1253.1 100
		5 – 7	black	Y6.112.0053.1			100		
		7 – 8	black	Y6.112.0253.1	100				
	with touring protection								



# Crimp contacts for 4.0 – 10 mm<sup>2</sup> conductor cross sections

## Female Connector

Crimp technology

Standard pack is delivered in a plastic bag. Delivery in complete standard packs only.

Use Wieland crimp tool only!

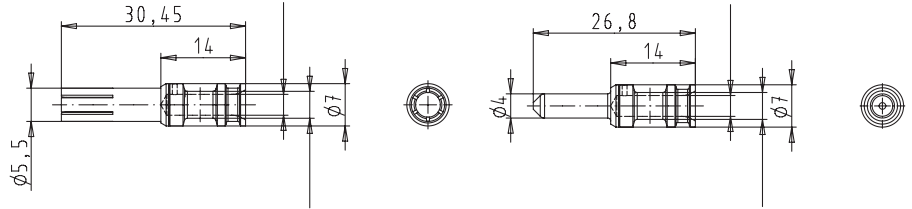

Marking	Cable cross section in mm <sup>2</sup>	AWG	Part No.	Std. Pack	Part No.	Std. Pack
			<b>Contact part – Female contact</b>		<b>Contact part – Male contact</b>	
			Insul. strip length	17 + 1 mm	Insul. strip length	17 + 1 mm
unmarked	4.0	12	02.125.8202.8	100	05.545.2202.8	100
1 groove	6.0	10	02.125.8302.8	100	05.545.2302.8	100
unmarked	10.0	8	02.125.8402.8	100	05.545.2402.8	100

## PST40i1 housing with turning protection

Complete intermateability with the existings PST40i1 system.  
Can be used in round and mould openings.  
High mechanical strength due to the 18mm thread.

## PST40i1 Mounting

**Use Wieland crimp tools only!**  
To be connected by specialists only!  
Tightening of the cable gland using flat wrench SW 13 for housings and SW 20 for nuts.  
Tightening torque for cable glands 3 – 3.5 Nm with TECSUN PV1-F cables.



## Technical data for PST40i1 connector system

Wire range:	min. 4.0 mm <sup>2</sup> ; min. 12 AWG;	max 10.0 mm <sup>2</sup> max. 8 AWG	TÜV version ETL version
Rated current: (without derating up to 85°C)	32 A at 4.0 mm <sup>2</sup> 40 A at 6.0 mm <sup>2</sup> 40 A at 10.0 mm <sup>2</sup>	(12 AWG) (10 AWG) (8 AWG)	
Rated voltage:	1000 V 600 V	(IEC/CEI) (UL/ETL)	TÜV version ETL version
Test voltage:	6 kV		
Overvoltage category:	CAT III (8 kV)		
Contact material:	solid brass, silver-plated		
Contact resistance:	< 0.15 mOhm (typ.)		
Flammability class:	UL94-V2 UL94-V0		TÜV version ETL version
Weathering resistance/ UV protection:	f1		
Pollution degree:	3		
Application class:	A		
Protection class:	II		
Degree of protection:	IP65 / IP66 / IP67 / IP68 (on request) (Specifications: plugged in or with cover piece)		
Insulation strip length:	17 + 1 mm		
Ambient temperature:	-40°C up to +85°C (+110°C upper limit temperature)		
Insulation material:	PA PC		TÜV version ETL version
Locking according to NEC 2008:	Yes, with locking clip		
Tightening torque:	3.5 Nm for cable glands to ensure strain relief and tightness		

### Installation instruction for field assembly:

The tightening torque must be adapted to the cable! Typical tightening torques range between 3 – 4 Nm. The solar cables from various manufacturers differ with regard to material, hardness and outer diameter. Therefore tightness of the cable glands must be checked in pre-assembly and the tightening torque must be increased for safety purposes, if required. When the TECSUN cable from Prysmian is used, tightness and strain relief are guaranteed with a torque of 3.5 Nm.

Basically the installer is responsible for proper cable layout and connector assembly.

**Notice:** **DC solar connectors must not be disconnected under load!**



# Technical data for PV cable

## TECSUN PV1-F

### Suitable for:

- Use in PV power supply systems
- Use outdoors and indoors with free and fixed layout
- Installation inside wireways, walls, or surface mount, electrical installation ducts and devices
- Suitable for protection class 2; short-circuit and ground-fault proof
- Basically the regulations in IEC 61215 und 61646. IEC 64/123/CD will apply. DIN VDE 0100 sect. 520



### Features / installation criteria:

Manufacturer:	Prysmian Kabel und Systeme GmbH. www.prysmian.com / www.special-cables-neustadt-coburg.de
Brand name:	TECSUN
Design ID:	PV1-F
Standards	
Approvals:	DIN VDE 0282 sect. 13. HD 22.13. VDE reg. no. 7985. TÜV certificate no. R 60010750-000 New requirements (2008) according to TÜV and VDE are fulfilled. Approval being prepared) UL 4703

### Special features:

- VDE and TÜV tested. EC declaration of conformity no. 03CE 004. UL 4703
- Expected lifecycle: 30 years when used as specified and with consideration of temperature, humidity, influence from ozone, UV and mechanical movement. Long-term behavior tests in line with IEC 6026 using Arrhenius.
- System voltage up to 2 kVDC. Test voltage 10 kVDC
- Operating temperature: cable –40 to +90 °C (+120 °C max. operating temperature)
- Very good fire resistance behavior in fire propagation and smoke emission as well as in corrodibility and very low toxicity of the smoke gas
- Halogen-free, meshed materials for insulation and sheath
- Ecological safety regarding recycling, waste disposal and manufacturing
- UV and ozone resistant

Rated voltage:	AC 0.6 / 1.0 kV
max. PV system voltage:	DC up to 2.0 kV possible
Operating voltage max.:	AC 0.7/1.2 kV / DC 0.9/1.8 kV
Test voltage:	AC / DC 6.0 / 10 kV (15 min)
Current-carrying capacity:	according to DIN VDE 0298 sect. 4
Tests:	accord. to DIN VDE 0282 sect. 2. HD 22.2 – cable resistance, voltage test AC and DC; dielectric strength, surface resistance (spark test), insulation resistance at 20 °C and 90 °C in water and at 120 °C in open air. EN 50305 sect. 6 – direct voltage resistance (10 days, 85 °C. in sea water, 1.5 kV DC)



## Accessories

### Cover plug



Description	Std. Pack	Part No.
<b>Male</b>		
without lanyard	50	05.566.6480.0
with lanyard	50	Z5.566.6480.0
<b>Female</b>		
without lanyard	50	05.566.6380.0
with lanyard	50	Z5.566.6380.0

**for protection of unplugged male or female connectors**

**for male housing**

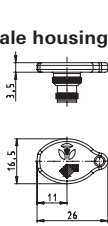

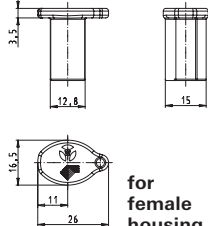

**for female housing**

### Locking clip



Description	Std. Pack	Part No.
<b>Locking clip</b>	100	05.568.2756.0



Locking clip (compliant with NEC 2008)  
can be opened with ordinary screwdriver

### Grounding grommet



Description	Std. Pack	Part No.
<b>Grounding grommet</b>	50	99.570.0000.7

For safe ground connection  
with customary tools.

### Extraction tool



Description	Std. Pack	Part No.
<b>Extraction tool</b>		99.305.0000.7



This tool can be used to extract the contact from the PST40i1 housing.



## Accessories

Multitool	Description		Color	Part No.
	<b>Multitool</b>	for 4 mm <sup>2</sup>	12 AWG	95.101.1500.0
	<b>Multitool</b>	for 6 mm <sup>2</sup>	10 AWG	95.101.1600.0

The Multitool can be used for cutting, stripping and crimping PV cables, replacing three tools with one Multitool!

Tool kit	Description		Color	Part No.
	<b>Crimp tool kit (small) for</b>	4.0/6.0/10.0 mm <sup>2</sup>		99.630.0000.0

**Contents:**

- Crimping tool
- Crimp die
- Crimping jaws D for 4.0 mm<sup>2</sup>, 6.0 mm<sup>2</sup> and 10.0 mm<sup>2</sup> contacts
- Extraction tool (for contacts)
- Strip tool

The crimp tool kit (small) is not shown here.

**Use Wieland crimp tools only!**

PST40i1 system kit	Description		Color	Part No.
	<b>PST40i1 system kit</b>		black	99.426.0000.0

  

**Contents:**

- Male and female connector housings
- Cable glands with O-rings
- Cover plugs
- Female contacts
- Male contacts
- Table of contents DIN A4

**Use Wieland crimp tools only!**

PST40i1 sample kit	Description		Color	Part No.
	<b>PST40i1 sample kit</b>		black	99.424.0000.0

  

**Trial set**

**Contents:**

- Connectors for field-assembly
- Bulkhead connectors
- Contacts
- Cable assemblies
- Cover plugs
- Extraction tool (for contacts)



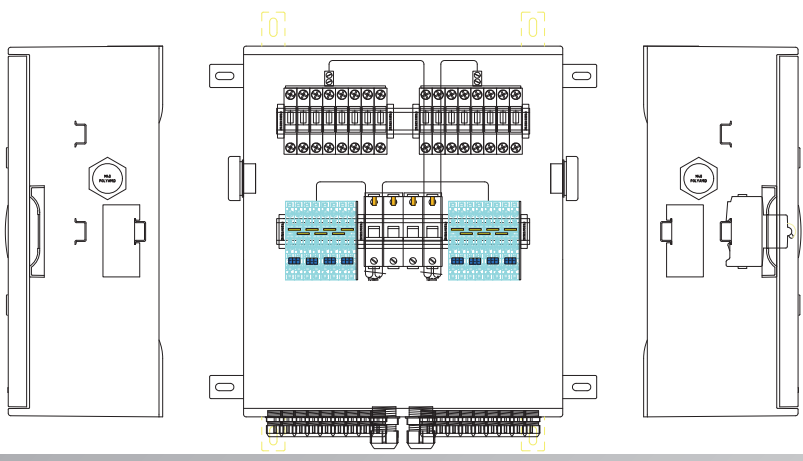
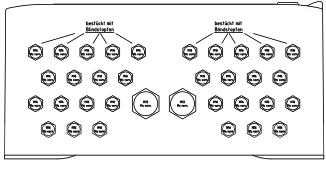

# Solar AC and DC Distribution Units For Your Projects

## Application example

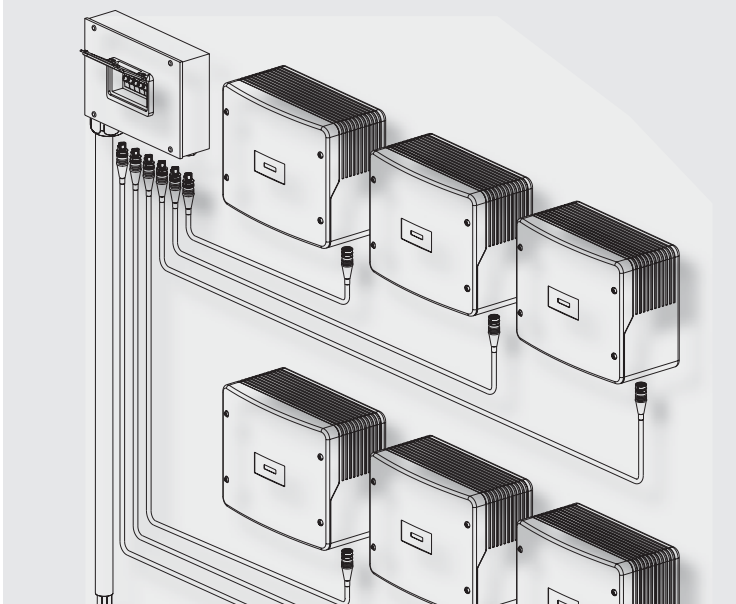

## Features:

- Distribution boxes for photovoltaic applications
- Protection class II
- UV-resistant polycarbonate housing, electric gray
- IP 65
- Ready for connection
- Optional lockout
- Prepared for grounding
- Passive ventilation (for climatic valves)
- Project-specific variations

## General

### System-based solution

Renewable energy sources are the future of energy generation – a future, the potential of which is still to be fully tapped.

To promote the effective and ecological use of renewable energy sources, we design, construct and market our **gesis** RAN SOLAR distribution units for photovoltaic promote installations. Our long term experience is continuously growing along with the requirements of the solar industry. When combined with the latest manufacturing technologies and our own solar testing facilities, featuring functionality and simulation programs, we guarantee high-quality **gesis** RAN SOLAR distribution panels for both the AC and DC side.

Wieland Electric GmbH, the leading manufacturer for connection technology, provides **gesis** RAN SOLAR distribution units that cover a spectrum from private residential systems to utility scale installations.





## Robust and flexible Solutions for the DC distribution unit

Wieland provides specialized electrotechnical components which are ideally suited for the construction of photovoltaic installations. All components are characterized by a high degree of reliability. The robust design enables uninterrupted operation even under rough conditions.



### DC distribution units – pluggable and customizable

The combiner box plays a major role in large photovoltaic plants. It bundles strings, enables isolation and overvoltage protection and can even be made pluggable. A complete range of specific components from DIN rail terminal blocks to overvoltage protection makes customization possible. Wieland Electric offers connection technology for use worldwide, whether with screw or spring clamp connection, 1.5 mm<sup>2</sup> or 240 mm<sup>2</sup> with VDE, UL or CSA approval.

**The combiner box is the interface between the array and the inverter. This component is very important for the smooth operation of a solar installation. With Wieland components this is guaranteed.**

**Solar installations expose electrotechnical components to the roughest conditions. The *gesis*<sup>AC</sup> SOLAR connectors from Wieland easily withstand these large climatic stresses.**



# Pluggable and Efficient

## Complete product range for solar installations

For solar installations Wieland offers not only the enormous advantages of pluggable connection technology, but also a comprehensive range of well-engineered and extensive interconnect technology suitable for combiner boxes, distribution boxes and control cabinets.

### Maximum efficiency

The **gesis** RAN SOLAR system always guarantees a high degree of efficiency. Due to this fact the installation can be implemented quickly and without errors – even under adverse weather conditions. This is possible using pre-assembled connectors and components providing IP 65 – IP 68 protection.

This advantage pays off not only for the initial installation. Individual components such as inverters, can be safely and quickly disconnected during maintenance via lockable connectors. Consistent protection against accidental contact as well as fast commissioning reduce the downtimes to a minimum.

### Maximum customization

Wieland not only supplies components, but also offers customized solutions. A broad standardized range can be customized with pluggable connectors and advanced interconnect technology. This is made possible by the large scope of the Wieland system, the compatibility of its components as well as our know-how.



### Benefits of a combiner box fitted with Wieland components:

- Pluggable connector PST 40i1 up to 10 mm<sup>2</sup>
- String collection
- Optional separation of individual strings
- Protection for inverters and array
- DC isolation between inverter and array
- Aluminum or copper conductors up to 1000V
- IEC, UL and CSA approvals





## **gesis**<sup>®</sup>RAN Planning Support Economical, cost-efficient and safe

When planning your projects you want to focus on your competencies. Make use of our competency in planning solar distribution units!

### **Minimize costs with top quality**

With **gesis** RAN solar distribution units, once complicated installations become a thing of the past. This saves time and reduces the costs. Furthermore you can be sure that everything will be assembled, tested and configured in accordance with currently valid regulations.

Our customers place value not only on top quality and on-time delivery, but also on efficient solutions. With our own, modern production plant and a highly motivated and experienced workforce we fulfill these criteria.

Wieland Electric stands for flexibility, know-how as well as for reliability, and works in accordance with national and international standards for manufacturing and testing (e.g. IEC, UL and CSA).

**gesis** RAN solar distribution units are manufactured according to VDE 0100 and IEC and meet protection class II.

A wide variety of clients take advantage of these benefits, and increase their competitive edge through cost reduction, and by focusing on their own core competencies.

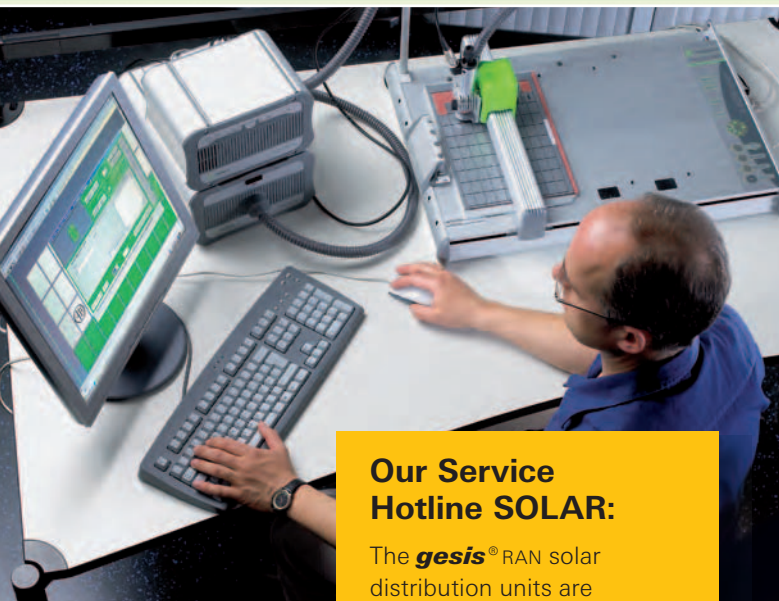

### **Our Service Hotline SOLAR:**

The **gesis**<sup>®</sup>RAN solar distribution units are configured for your project and delivered on time and ready for installation. Ask our experts!  
**Phone: +49-9 51 93 24-972**





### Excellence in project fulfillment

Our innovative **gesis** RAN solar distribution units are the key for efficient and failsafe operation of the installation, and perform as the "gateway to the grid".

Our capabilities as a specialist for energy distribution as well as our staff's extensive project experience make us an ideal partner for the implementation of solar installations. A special staff team supports planning of photovoltaic projects and develops customized **gesis** RAN solar distribution units including CAD documentation.

Special value is placed on a robust and user-friendly design of the **gesis** RAN solar distribution units. The **gesis** RAN solar distribution units are configured for your project and delivered on time and ready for installation.

**Ask our experts!**

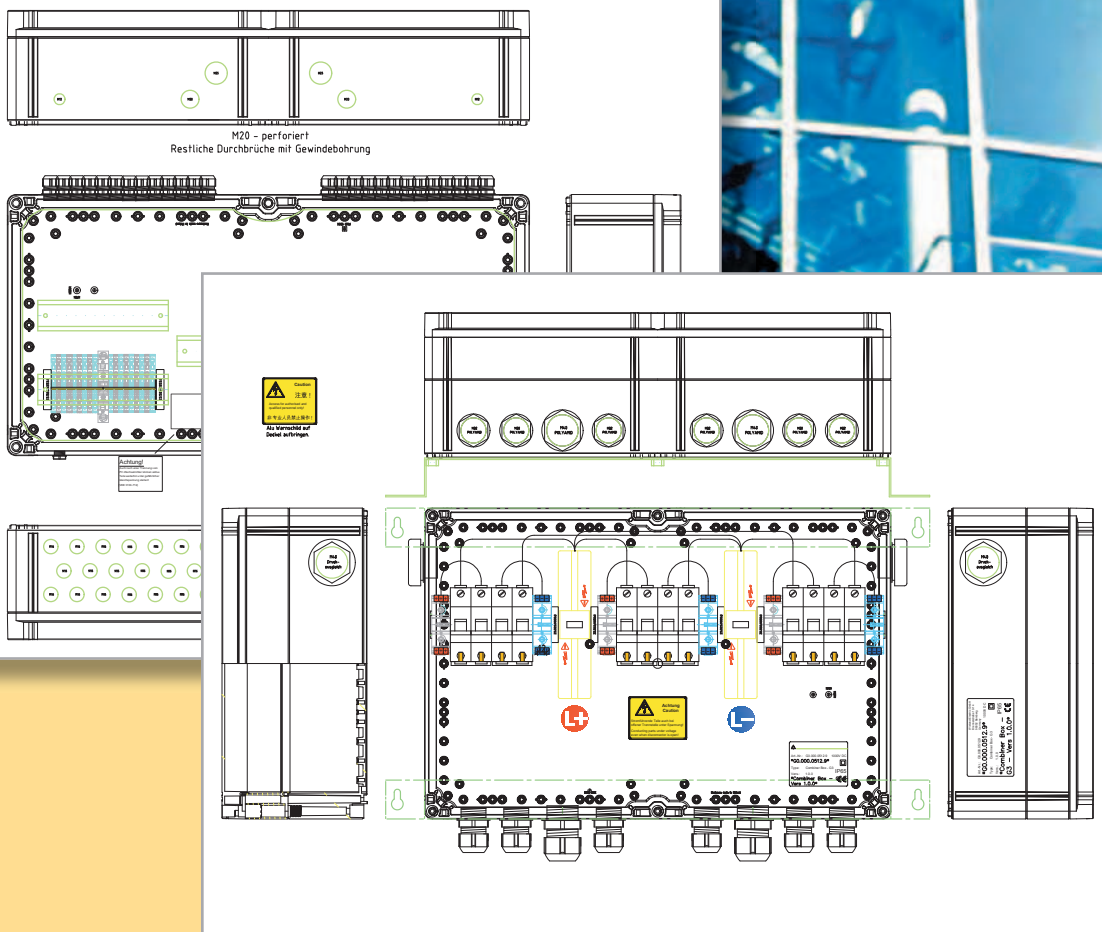



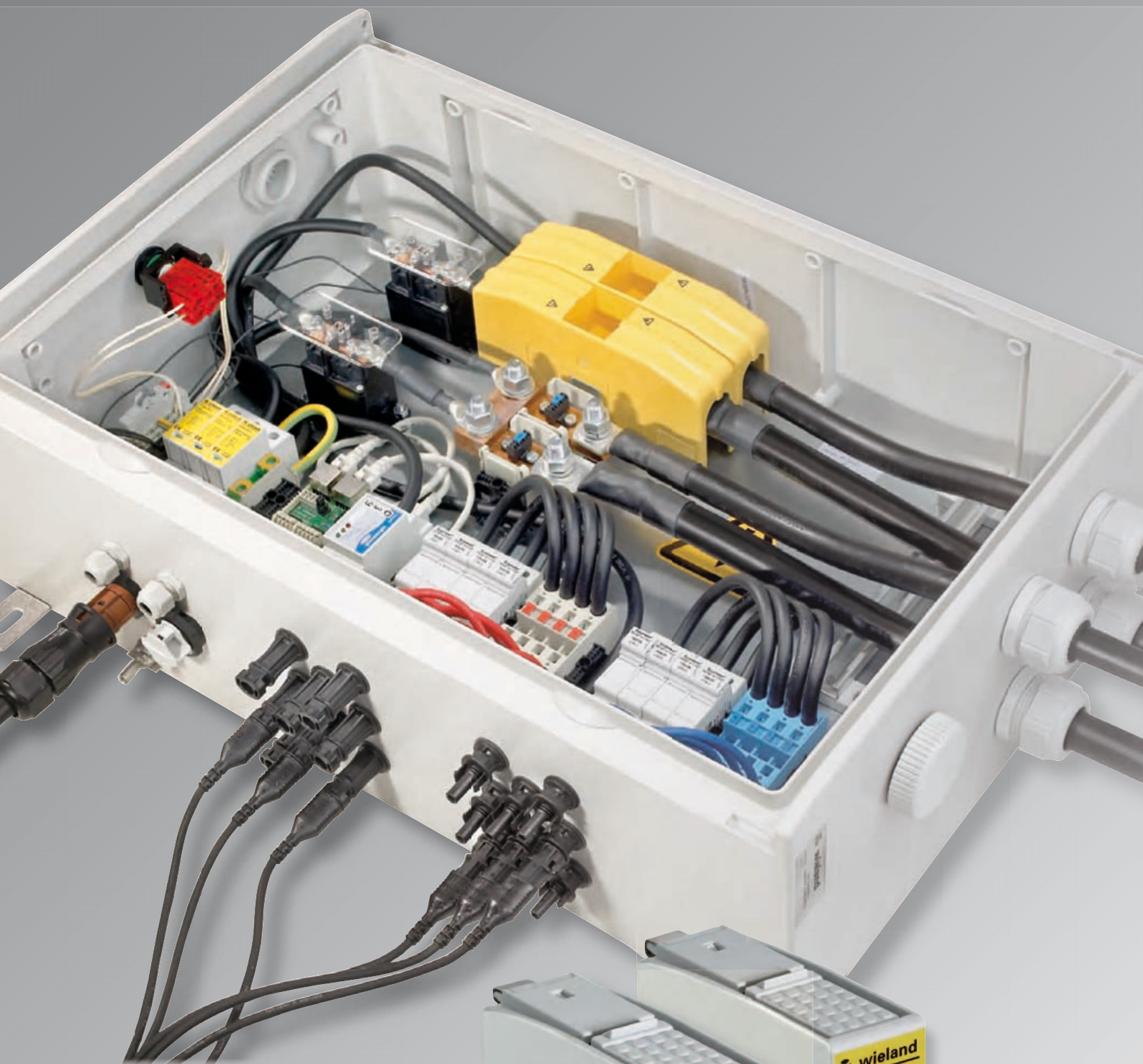

# Overvoltage protection and string monitoring for photovoltaic systems

## Application example

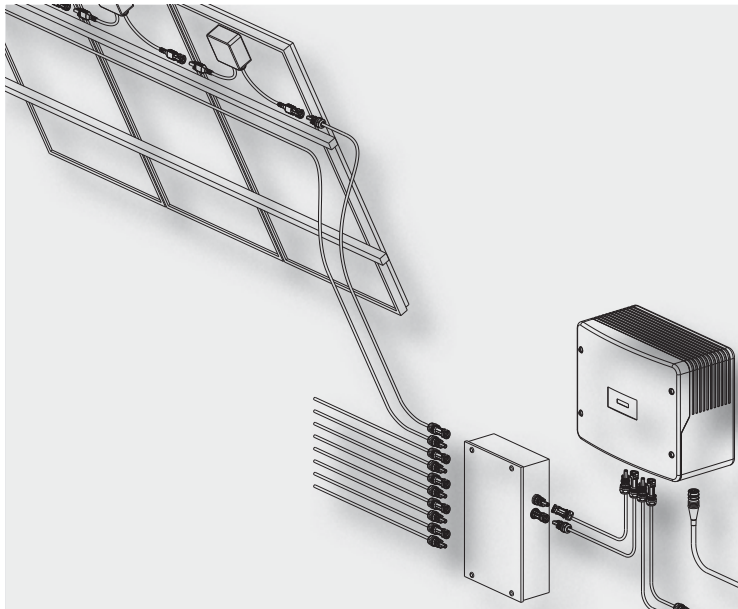

## General

Photovoltaic systems, abbreviated as PV systems, are a considerable investment that must be protected from failure and damage. As these systems are installed outdoors, they are exposed to the danger of overvoltage from lightning strikes.

### Overvoltage protection in the DC circuit with central inverters

The generator circuit (the PV modules) produces a direct current. Connecting the PV modules and arrays in series allows voltages of 1000 V to be reached. This combination with the fact that the generator circuit can continue to supply energy after overvoltage requires sophisticated technology for the overvoltage arrester.

### Overvoltage protection in the AC circuit with string inverters

If smaller decentralized or string inverters are used, the energy produced must be collected on the AC side. As this collection is also in danger of overvoltage, the appropriate protection measures must be taken.

Further information on the complete overvoltage protection product range can be found in the catalog

0800.1 "interface – solutions for the control cabinet"

and the products can also be found online via our e-catalog, which also provides more information, drawings, etc.



## DC overvoltage protection:

The PV/DC overvoltage arresters are specially designed for use in PV systems. Both the housing technology and the connections are designed for the requirements of a PV system's high voltages and conductor cross-sections. With a width of only 48mm, the units are easily installed inside distribution panels, requiring the minimum of space.

- For applications in all PV systems in accordance with IEC 60364-7-712
- High discharge capacity due to powerful zinc-oxide varistor
- No fire hazard caused by permanent electric arc due to combined disconnect and short-circuit facility. Overload indicated in display window
- Signaling contacts for remote monitoring in all remote signaling types

## AC overvoltage protection:

On the AC side of the inverters overvoltage protection must also be installed. The arresters listed here are the most commonly used versions.

- Prewired combined spark-gap based surge arrester consisting of a base component and pluggable protection modules
- Maintenance-friendly thanks to pluggable protection modules
- Discharge capacity up to 100 kA (10/350)
- Function and fault display
- Signaling contacts for remote monitoring in all remote signaling types





# Overvoltage arresters 600V DC

## wietap GM YPV SCI 600 (FM) For use in PV system current circuits

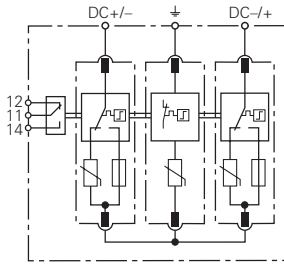

Type	Part No.
<b>wietap GM YPV SCI 600FM</b>	84.995.2516.0
<b>Replacement module</b>	
"+" or "-" against internal neutral point	84.995.2053.0
Internal neutral point against $\perp$	84.995.2010.0

Technical Data	
SPD-accord. to EN 61643-11	Type 2
SPD-accord. to IEC 61643-1	Class II
Maximum PV voltage [UPV <sub>max</sub> ]	≤ 600 V
Total discharge current (8/20) [I <sub>total</sub> ]	40 kA
Nominal discharge current (8/20) [(DC+/DC-) → PE] [I <sub>n</sub> ]	12.5 kA
Max. discharge current (8/20) [(DC+/DC-) → PE] [I <sub>max</sub> ]	25 kA
Protection level [U <sub>p</sub> ]	≤ 2.5 kV
Protection level bei 5 kA [U <sub>p</sub> ]	≤ 2 kV
Operating time [t <sub>a</sub> ]	≤ 25 ns
Temperature range [T <sub>U</sub> ]	-40 °C...+80 °C
Current breaking capacity of the internal fuse	30 kA / 1000 V DC
Function/failure indication	green / red
Wire range (min.)	1.5 mm <sup>2</sup> solid/fine-stranded
Wire range (max.)	35 mm <sup>2</sup> stranded/25 mm <sup>2</sup> fine-stranded
Mounted on DIN rail acc. to EN 60715	35 mm
Housing material	Thermoplast, UL 94 V-0
Degree of protection	IP 20
Dimensions	3 TE, DIN 43880 (54 mm)
FM contacts / contact form	Change-over contact
Switching capacity AC (FM)	250 V/0.5 A
Switching capacity DC (FM)	250 V/0.1 A; 125 V/0.2 A; 75 V/0.5 A
Connector cross-section for FM terminals	max. 1.5 mm <sup>2</sup> solid/fine-stranded
Approvals	CE

- Photovoltaic arrester
- Complete modular unit wired ready for use
- Type 2 classification according to EN 61643-11
- Safe, arc-free replacement of protection modules thanks to integrated DC fuse
- There is no danger of fire in the event of an overload thanks to a combined separator and short-circuiting device with safe electrical separation in the protection module.
- Can be used with all PV systems acc. to IEC 60364-7-712
- High discharge capacity
- Function/failure indication
- Optional with remote signaling contact

## Replacement module for wietap GM YPV SCI 600 (FM)

"+" or "-" against internal neutral point <b>wietap G MOD PV SCI 300</b>  Internal neutral point against $\perp$ <b>wietap G MOD 275</b>	Type	Part No.
	<b>wietap G MOD PV SCI 300</b>	84.995.2053.0
	<b>wietap G MOD 275</b>	84.995.2010.0

# Overvoltage arresters 1000V DC

## wietap GM YPV SCI 1000 (FM) For use in PV system current circuits

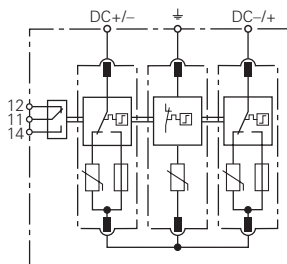

Type	Part No.
<b>wietap GM YPV SCI 1000FM</b>	84.995.2515.0
<b>Replacement module</b>	
"+" or "-" against internal neutral point	84.995.2051.0
Internal neutral point against $\pm$	84.995.2015.0

Technical Data	
SPD-accord. to EN 61643-11	Type 2
SPD-accord. to IEC 61643-1	Class II
Maximum PV voltage [UPV <sub>max</sub> ]	≤ 1000 V
Total discharge current (8/20) [I <sub>total</sub> ]	40 kA
Nominal discharge current (8/20) [(DC+/DC-) → PE] [I <sub>n</sub> ]	12,5 kA
Max. discharge current (8/20) [(DC+/DC-) → PE] [I <sub>max</sub> ]	25 kA
Protection level [U <sub>p</sub> ]	≤ 4 kV
Protection level bei 5 kA [U <sub>p</sub> ]	≤ 3.5 kV
Operating time [t <sub>a</sub> ]	≤ 25 ns
Temperature range [T <sub>U</sub> ]	-40 °C...+80 °C
Current breaking capacity of the internal fuse	30 kA / 1000 V DC
Function/failure indication	green / red
Wire range (min.)	1,5 mm <sup>2</sup> solid/fine-stranded
Wire range (max.)	35 mm <sup>2</sup> stranded/25 mm <sup>2</sup> fine-stranded
Mounted on DIN rail acc. to EN 60715	35 mm
Housing material	Thermoplast, UL 94 V-0
Degree of protection	IP 20
Dimensions	3 TE, DIN 43880 (54 mm)
FM contacts / contact form	Changeover contact
Switching capacity AC (FM)	250 V/0.5 A
Switching capacity DC (FM)	250 V/0.1 A; 125 V/0.2 A; 75 V/0.5 A
Connector cross-section for FM terminals	max. 1.5 mm <sup>2</sup> solid/fine-stranded
Approvals	CE, VDE, TÜV

- Photovoltaic arrester
- Complete modular unit wired ready for use
- Type 2 classification according to EN 61643-11
- Safe, arc-free replacement of protection modules thanks to integrated DC fuse
- There is no danger of fire in the event of an overload thanks to a combined separator and short-circuiting device with safe electrical separation in the protection module.
- Can be used with all PV systems acc. to IEC 60364-7-712
- High discharge capacity
- Function/failure indication
- Optional with remote signaling contact

## Replacement module for wietap GM YPV SCI 1000 (FM)

"+" or "-" against internal neutral point  
**wietap G MOD PV SCI 500**

Internal neutral point against PE  
**wietap G MOD 440**

Type	Part No.
<b>wietap G MOD PV SCI 500</b>	84.995.2051.0
<b>wietap G MOD 440</b>	84.995.2015.0

# 3-phase AC combination arrester, type 1 (2, 3)

## wietap V M TNC 255 (FM) For protection of the main building supply

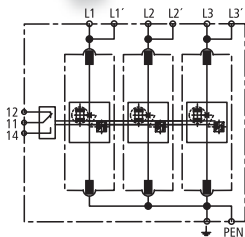

- Combined arrester, type 1
- For TN-C-systems
- With pluggable protection modules
- Max. system availability due to follow current limitation
- Switch-off selective for 20 A gL/gG fuses up to 50 kA<sub>eff</sub> short-circuit current
- Discharge capacity up to 75 kA (10/350)
- Function/failure indication according to VDE 0100-534 (valid since March 2009)
- Optional with remote signaling contact
- Vibration and shock tested acc. to EN 60068-2

Type	Part No.
<b>wietap V M TNC 255 FM</b>	84.995.1305.0
<b>Replacement module</b>	
L1, L2, L3 against $\varnothing$	84.995.1001.0
Power network	TN-C
SPD accord. to 61643-11 / IEC 61643-1	Type 1 / Class I
Energy-coordinated protective function to the end device	Type 1 + Type 2
Energy-coordinated protective function to the end device $\leq 5m$	Type 1 + Type 2 + Type 3
Nominal voltage AC [U <sub>N</sub> ]	230 / 400 V
Nominal frequency [f <sub>N</sub> ]	50 / 60 Hz
Maximum continuous voltage AC [U <sub>c</sub> ]	255 V
Lightn. impulse current (10/350) [L1+L2+L3-PEN] [I <sub>total</sub> ]	75 kA
Lightn. impulse current (10/350) [L-PEN] [I <sub>imp</sub> ]	25 kA
Nominal discharge current (8/20) [I <sub>n</sub> ]	25 / 75 kA
Protection level [U <sub>p</sub> ]	$\leq 1.5$ kV
Follow current extinction capability AC [I <sub>e</sub> ]	50 kA <sub>eff</sub>
Operating time [t <sub>a</sub> ]	$\leq 100$ ns
Max. pre-fusing (L) up to I <sub>k</sub> = 50 kA <sub>eff</sub>	315 A gL/gG
Max. pre-fusing (L) bei I <sub>k</sub> > 50 kA <sub>eff</sub>	200 A gL/gG
Max. pre-fusing (L-L')	125 A gL/gG
TOV-voltage [U <sub>T</sub> ]	440 V / 5 sec.
Temperature range (Parallel wiring) [T <sub>up</sub> ]	-40°C...+80 °C
Temperature range (Through wiring) [T <sub>us</sub> ]	-40°C...+60 °C
Function/failure indication	green / red
Wire range (L1, L1', L2, L2', L3, L3', PEN, $\varnothing$ ) [min.]	10 mm <sup>2</sup> solid/fine-stranded
Wire range (L1, L2, L3, PEN) [max.]	50 mm <sup>2</sup> stranded/35 mm <sup>2</sup> fine-stranded
Wire range (L1', L2', L3', $\varnothing$ ) [max.]	35 mm <sup>2</sup> stranded/25 mm <sup>2</sup> fine-stranded
Mounted on DIN rail acc. to EN 60715	35 mm
Housing material	Thermoplast, UL 94 V-0
Degree of protection	IP 20
Dimensions	6 TE, DIN 43880 (108 mm)
FM contacts / contact form	Change-over contact
Switching capacity AC (FM)	250 V/0.5 A
Switching capacity DC (FM)	250 V/0.1 A; 125 V/0.2 A; 75 V/0.5 A
Wire range FM terminals	max. 1.5 mm <sup>2</sup> solid/fine-stranded
Approvals	CE

## wietap V M TNS 255 (FM) For protection of the main building supply

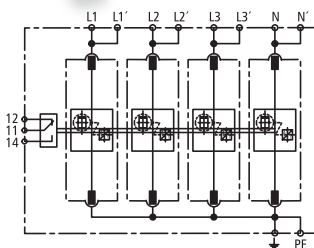

- Combined arrester Type 1
- For TN-S-Systeme
- With pluggable protection modules
- Max. system availability due to follow current limitation
- Switch-off selective for 20 A gL/gG fuses up to 50 kA<sub>eff</sub> short-circuit current
- Discharge capacity up to 100 kA (10/350)
- Function/failure indication according to VDE 0100-534 (valid since March 2009)
- Optional with remote signaling contact
- Vibration and shock tested acc. to EN 60068-2

Typ	Bestell-Nr.
<b>wietap V M TNS 255 FM</b>	84.995.1405.0
<b>Replacement module</b>	
L1, L2, L3, N against $\varnothing$	84.995.1001.0
Power network	TN-S
SPD accord. to EN 61643-11 / IEC 61643-1	Type 1 / Class I
Energy-coordinated protective function to the end device	Type 1 + Type 2
Energy-coordinated protective function to the end device $\leq 5m$	Type 1 + Type 2 + Type 3
Nominal voltage AC [U <sub>N</sub> ]	230 / 400 V
Nominal frequency [f <sub>N</sub> ]	50 / 60 Hz
Maximum continuous voltage AC [U <sub>c</sub> ]	255 V
Lightn. impulse current (10/350) [L1+L2+L3+N-PE] [I <sub>total</sub> ]	100 kA
Lightn. impulse current (10/350) [L, N-PE] [I <sub>imp</sub> ]	25 kA
Nominal discharge current (8/20) [I <sub>n</sub> ]	25 / 100 kA
Protection level [L, N-PE] [U <sub>p</sub> ]	$\leq 1.5$ kV
Follow current extinction capability AC [I <sub>e</sub> ]	50 kA <sub>eff</sub>
Operating time [t <sub>a</sub> ]	$\leq 100$ ns
Max. pre-fusing (L) up to I <sub>k</sub> = 50 kA <sub>eff</sub>	315 A gL/gG
Max. pre-fusing (L) bei I <sub>k</sub> > 50 kA <sub>eff</sub>	200 A gL/gG
Max. pre-fusing (L-L')	125 A gL/gG
TOV-voltage [L-N] [U <sub>T</sub> ]	440 V / 5 sec.
Temperature range (Parallel wiring) [T <sub>up</sub> ]	-40 °C...+80 °C
Temperature range (Through wiring) [T <sub>us</sub> ]	-40 °C...+60 °C
Function/failure indication	green / red
Wire range (L1, L1', L2, L2', L3, L3', N, N', PE, $\varnothing$ ) [min.]	10 mm <sup>2</sup> solid/fine-stranded
Wire range (L1, L2, L3, PE, N) [max.]	50 mm <sup>2</sup> stranded/35 mm <sup>2</sup> fine-stranded
Wire range (L1', L2', L3', N', $\varnothing$ ) [max.]	35 mm <sup>2</sup> stranded/25 mm <sup>2</sup> fine-stranded
Mounted on DIN rail acc. to EN 60715	35 mm
Housing material	Thermoplast, UL 94 V-0
Degree of protection	IP 20
Dimensions	8 TE, DIN 43880 (144 mm)
FM contacts / contact form	Change-over contact
Switching capacity AC (FM)	250 V/0.5 A
Switching capacity DC (FM)	250 V/0.1 A; 125 V/0.2 A; 75 V/0.5 A
Wire range FM terminals	max. 1.5 mm <sup>2</sup> solid/fine-stranded
Approvals	CE



# 3-phase AC combination arrester, type 1 (2, 3)

## wietap V M TT 255 (FM) For protection of the main building supply

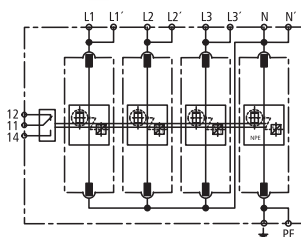

- Combined arrester Type 1
- For TT- and TN-S-systems ("3+1" circuits)
- With pluggable protection modules
- Max. system availability due to follow current limitation
- Switch-off selective for 20 A gL/gG fuses up to 50 kA<sub>eff</sub> short-circuit current
- Discharge capacity up to 100 kA (10/350)
- Function/failure indication according to VDE 0100-534 (valid since March 2009)
- Optional with remote signaling contact
- Vibration and shock tested acc. to EN 60068-2

Type	Part No.
<b>wietap V M TT 255 FM</b>	84.995.1315.0
<b>Replacement module</b>	
L1, L2, L3 against N	84.995.1001.0
N against $\perp$	84.995.1100.0
Power network	TT und TN-S
SPD accord. to 61643-11 / 61643-1	Type 1 / Class I
Energy-coordinated protective function to the end device	Type 1 + Type 2
Energy-coordinated protective function to the end device $\leq$ 5m	Type 1 + Type 2 + Type 3
Nominal voltage AC [U <sub>n</sub> ]	230 / 400 V
Nominal frequency [f <sub>n</sub> ]	50 / 60 Hz
Maximum continuous voltage AC [U <sub>c</sub> ]	255 V
Lightn. impulse current (10/350) [L1+L2+L3 +N-PE] [I <sub>total</sub> ]	100 kA
Lightn. impulse current (10/350) [L-N] [I <sub>imp</sub> ]	25 kA
Lightn. impulse current (10/350) [N-PE] [I <sub>imp</sub> ]	100 kA
Nominal discharge current (8/20) [I <sub>n</sub> ]	25 / 100 kA
Protection level [L-N, N-PE] [U <sub>p</sub> ]	$\leq$ 1,5 kV
Follow current extinction capability [L-N] AC [I <sub>n</sub> ]	50 kA <sub>eff</sub>
Follow current extinction capability [N-PE] AC [I <sub>n</sub> ]	100 A <sub>eff</sub>
Operating time [t <sub>a</sub> ]	$\leq$ 100 ns
Max. pre-fusing (L) up to I <sub>k</sub> = 50 kA <sub>eff</sub>	315 A gL/gG
Max. pre-fusing (L) bei I <sub>k</sub> > 50 kA <sub>eff</sub>	200 A gL/gG
Max. pre-fusing (L-L')	125 A gL/gG
TOV-voltage [L-N] [U <sub>v</sub> ]	440 V / 5 sec.
TOV-voltage [N-PE] [U <sub>v</sub> ]	1200 V / 200 ms
Temperature range (Parallel wiring) [T <sub>up</sub> ]	-40 °C...+80 °C
Temperature range (Through wiring) [T <sub>us</sub> ]	-40 °C...+60 °C
Function/failure indication	green / red
Wire range(L1, L1', L2, L2', L3, L3', N, N', PE, $\perp$ ) [min.]	10 mm <sup>2</sup> solid/fine-stranded
Wire range (L1, L2, L3, N, PE) [max.]	50 mm <sup>2</sup> stranded/35 mm <sup>2</sup> fine-stranded
Wire range (L1', L2', L3', N, $\perp$ ) [max.]	35 mm <sup>2</sup> stranded/25 mm <sup>2</sup> fine-stranded
Mounted on DIN rail acc. to EN 60715	35 mm
Housing material	Thermoplast, UL 94 V-0
Degree of protection	IP 20
Dimensions	8 TE, DIN 43880 (144 mm)
FM contacts / contact form	Change-over contact
Switching capacity AC (FM)	250 V/0.5 A
Switching capacity DC (FM)	250 V/0.1 A; 125 V/0.2 A; 75 V/0.5 A
Wire range Remote signaling terminals	max. 1.5 mm <sup>2</sup> solid/fine-stranded
Approvals	CE

## Replacement module for wietap V M devices

### wietap V MOD 255

Network spark gap protection module for all L -  $\perp$ ; L - N and wietap V M TNS 255 (FM) N -  $\perp$



### wietap V MOD NPE 100

Network spark gap protection module for wietap V M TT 255 (FM) N -  $\perp$



Type	Part No.
<b>wietap V MOD 255</b>	84.995.1001.0
<b>wietap V MOD NPE 100</b>	84.995.1100.0

# 3-phase lightning arrester, AC, type 1

**wietap B3 255H**  
For protection of the main building supply

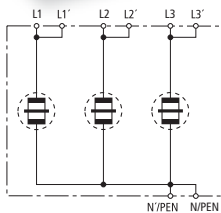

- Lightning arrester, type 1
- For all systems (in connection with **wietap** GPM 255 if required)
- High limitation of follow current
- 50 kA discharge capacity per pole
- High insulation resistance; can therefore also be placed in front of the meter
- Double terminals for V connection

Type	Part No.
<b>wietap B3 255H</b>	84.995.0120.0
<b>Technical Data</b>	
SPD accord. to EN 61643-11	Type 1
SPD accord. to IEC 61643-1	Class I
Nominal voltage AC [U <sub>N</sub> ]	230/400 V
Maximum continuous voltage AC [U <sub>c</sub> ]	255 V
Lightn. impulse current (10/350) [L-N/PEN] [I <sub>imp</sub> ]	50 kA
Lightn. impulse current (10/350) [L1+L2+L3-N/PEN] [I <sub>total</sub> ]	100 kA
Nominal discharge current (8/20) [I <sub>n</sub> ]	50 / 100 kA
Protection level [U <sub>p</sub> ]	≤ 4 kV
Follow current extinction capability AC [I <sub>a</sub> ]	50 kA <sub>eff</sub>
Limitation of follow current / selectivity	Non-tripping of a 35 A gL/gG fuse up to 50 kA <sub>eff</sub> (prosp.)
Operating time [t <sub>a</sub> ]	≤ 100 ns
Max. pre-fusing up to I <sub>k</sub> = 50 kA <sub>eff</sub> (ta ≤ 0,2 s)	500 A gL/gG
Max. pre-fusing up to I <sub>k</sub> = 50 kA <sub>eff</sub> (ta ≤ 5 s)	315 A gL/gG
Max. pre-fusing bei I <sub>k</sub> > 50 kA <sub>eff</sub>	200 A gL/gG
Max. pre-fusing (L-L')	125 A gL/gG
TOV-voltage [U <sub>T</sub> ]	335 V / 5 sec.
Temperature range (Parallel wiring) [T <sub>UP</sub> ]	-40 °C...+80 °C
Temperature range (Through wiring) [T <sub>US</sub> ]	-40 °C...+60 °C
Wire range (L1, L1', L2, L2', L3, L3', N/PEN, N'/PEN)	10 mm <sup>2</sup> solid/fine-stranded
Wire range (L1, L2, L3, N/PEN)	50 mm <sup>2</sup> stranded/35 mm <sup>2</sup> fine-stranded
Wire range (L1', L2', L3', N'/PEN)	35 mm <sup>2</sup> stranded/25 mm <sup>2</sup> fine-stranded
Mounted on DIN rail acc. to EN 60715	35 mm
Housing material	Thermoplast, UL 94 V-0
Degree of protection	IP 20
Dimensions	6 TE, DIN 43880 (108 mm)
Approvals	CE

# N-PE lightning arrester, AC, type 1

## wietap GMP 255

For protection of the main building supply

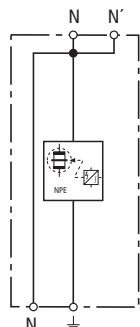

- N-PE AC lightning arrester, type 1
- in combination with **wietap** B1 255H or **wietap** B3 255H
- 100 kA discharge capacity

Type	Part No.
<b>wietap</b> GPM 255	84.995.0055.0
<b>Technical Data</b>	
SPD accord. to EN 61643-11	Type 1
SPD accord. to IEC 61643-1	Class I
Maximum continuous voltage AC [U <sub>c</sub> ]	255 V
Lightn. impulse current (10/350) [I <sub>imp</sub> ]	100 kA
Nominal discharge current (8/20) [I <sub>n</sub> ]	100 kA
Protection level [U <sub>p</sub> ]	≤ 1,5 kV
Follow current extinction capability AC [I <sub>n</sub> ]	100 A <sub>eff</sub>
Operating time [t <sub>a</sub> ]	≤ 100 ns
TOV-voltage	1200 V / 200 ms
Temperature range (Parallel wiring) [T <sub>UP</sub> ]	-40 °C...+80 °C
Temperature range (Through wiring) [T <sub>US</sub> ]	-40 °C...+60 °C
Function/failure indication	green / red
Wire range (min.)	10 mm <sup>2</sup> solid/fine-stranded
Wire range (max.)	50 mm <sup>2</sup> stranded/35 mm <sup>2</sup> fine-stranded
Mounted on DIN rail acc. to EN 60715	35 mm
Housing material	Thermoplast, UL 94 V-0
Degree of protection	IP 20
Dimensions	2 TE, DIN 43880 (36 mm)
Approvals	CE

# L-PE AC lightning arrester, type 1

## wietap B1 255H

For protection of the main building supply

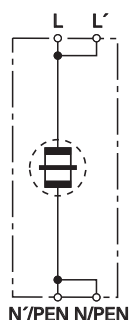

- L-PE AC lightning arrester, type 1
- For all systems (in connection with **wietap** GPM 255 if required)
- High limitation of follow current
- 50 kA discharge capacity per pole
- High insulation resistance; can therefore also be placed in front of the meter
- Double terminals for V connection

Type	Part No.
<b>wietap</b> B1 255H	84.995.0222.0
<b>Technical Data</b>	
SPD accord. EN 61643-11	Type 1
SPD accord. to IEC 61643-1	Class I
Nominal voltage ac [U <sub>n</sub> ]	230 V
Maximum continuous voltage ac [U <sub>c</sub> ]	255 V
Lightn. impulse current (10/350) [I <sub>imp</sub> ]	50 kA
Nominal discharge current (8/20) [I <sub>n</sub> ]	50 kA
Protection level [U <sub>p</sub> ]	≤ 4 kV
Follow current extinction capability ac [I <sub>n</sub> ]	50 kA <sub>eff</sub>
Limitation of follow current / selectivity	Non-tripping of a 35 A gL/gG fuse up to 50 kA <sub>eff</sub> (prosp.)
Operating time [t <sub>a</sub> ]	≤ 100 ns
Max. pre-fusing up to I <sub>k</sub> = 50 kA <sub>eff</sub> (t <sub>a</sub> ≤ 0,2 s)	500 A gL/gG
Max. pre-fusing up to I <sub>k</sub> = 50 kA <sub>eff</sub> (t <sub>a</sub> ≤ 5 s)	315 A gL/gG
Max. pre-fusing bei I <sub>k</sub> > 50 kA <sub>eff</sub>	200 A gL/gG
Max. pre-fusing (L-L')	125 A gL/gG
TOV-voltage [U <sub>T</sub> ]	335 V / 5 sec.
Temperature range (Parallel wiring) [T <sub>UP</sub> ]	-40 °C...+80 °C
Temperature range (Through wiring) [T <sub>US</sub> ]	-40 °C...+60 °C
Wire range (L, L', N/PEN, N'/PEN) [min.]	10 mm <sup>2</sup> solid/fine-stranded
Wire range (L, N/PEN) [max.]	50 mm <sup>2</sup> stranded/35 mm <sup>2</sup> fine-stranded
Wire range (L', N'/PEN) [max.]	35 mm <sup>2</sup> stranded/25 mm <sup>2</sup> fine-stranded
Mounted on DIN rail acc. to EN 60715	35 mm
Housing material	Thermoplast, UL 94 V-0
Degree of protection	IP 20
Dimensions	2 TE, DIN 43880 (36 mm)
Approvals	CE



## 3-phase AC overvoltage arrester, type 2

### wietap G M TNC 275 (FM)

For the protection of sub-systems or the control cabinet supply

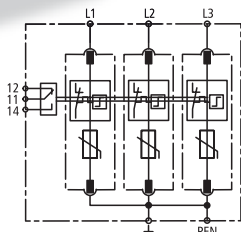

- Surge arrester, type 2
- For TN-C-systems
- With pluggable protection modules
- Function/failure indication according to VDE 0100-534 (valid since March 2009)
- Optional with remote signaling contact
- Vibration and shock tested acc. to EN 60068-2

Type	Part No.
<b>wietap G M TNC 275 FM</b>	84.995.2305.0
<b>Replacement module</b>	
L1, L2, L3 against $\neq$	84.995.2010.0
Power network	TN-C
SPD accord. to EN 61643-11	Type 2
SPD accord. to IEC 61643-1	Class II
Nominal voltage AC [U <sub>N</sub> ]	230/400 V
Nominal frequency [f <sub>N</sub> ]	50 / 60 Hz
Maximum continuous voltage AC [U <sub>C</sub> ]	275 V
Nominal discharge current (8/20) [I <sub>n</sub> ]	20 kA
Max. discharge current (8/20) [I <sub>max</sub> ]	40 kA
Protection level [U <sub>p</sub> ]	≤ 1.25 kV
Protection level bei 5 kA [U <sub>p</sub> ]	≤ 1 kV
Operating time [t <sub>a</sub> ]	≤ 25 ns
Maximum network overcurrent protection	125 A gL/gG
Short-circuit proof for max network overcurrent protection	up to 50 kA <sub>eff</sub>
TOV-voltage [U <sub>T</sub> ]	335 V / 5 sec.
Temperature range [T <sub>U</sub> ]	-40 °C...+80 °C
Function/failure indication	green / red
Wire range (min.)	1.5 mm <sup>2</sup> solid/fine-stranded
Wire range (max.)	35 mm <sup>2</sup> stranded/25 mm <sup>2</sup> fine-stranded
Mounted on DIN rail acc. to EN 60715	35 mm
Housing material	Thermoplast, UL 94 V-0
Degree of protection	IP 20
Dimensions	3 TE, DIN 43880 (54 mm)
FM contacts / contact form	Change-over contact
Switching capacity AC (FM)	250 V/0.5 A
Switching capacity DC (FM)	250 V/0.1 A; 125 V/0.2 A; 75 V/0.5 A
Wire range remote signaling terminals	max. 1.5 mm <sup>2</sup> solid/fine-stranded
Approvals	CE

### wietap G M TT 275 (FM)

For the protection of sub-systems or the control cabinet supply

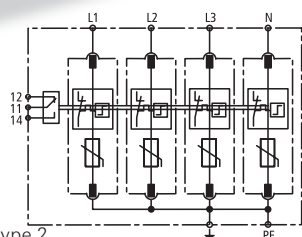

- Surge arrester, type 2
- For TN-S-systems
- With pluggable protection modules
- Function/failure indication according to VDE 0100-534 (valid since March 2009)
- Optional with remote signaling contact
- Vibration and shock tested acc. to EN 60068-2

Type	Part No.
<b>wietap G M TNS 275 FM</b>	84.995.2405.0
<b>Replacement module</b>	
L1, L2, L3, N against $\neq$	84.995.2010.0
Power network	TN-S
SPD accord. to EN 61643-11	Type 2
SPD accord. to IEC 61643-1	Class II
Nominal voltage AC [U <sub>N</sub> ]	230/400 V
Nominal frequency [f <sub>N</sub> ]	50 / 60 Hz
Maximum continuous voltage AC [U <sub>C</sub> ]	275 V
Nominal discharge current (8/20) [I <sub>n</sub> ]	20 kA
Max. discharge current (8/20) [I <sub>max</sub> ]	40 kA
Protection level [U <sub>p</sub> ]	≤ 1.25 kV
Protection level bei 5 kA [U <sub>p</sub> ]	≤ 1 kV
Operating time [t <sub>a</sub> ]	≤ 25 ns
Maximum network overcurrent protection	125 A gL/gG
Short-circuit proof for maximum network current protection	up to 50 kA <sub>eff</sub>
TOV-voltage [U <sub>T</sub> ]	335 V / 5 sec.
Temperature range [T <sub>U</sub> ]	-40 °C...+80 °C
Function/failure indication	green / red
Wire range (min.)	1.5 mm <sup>2</sup> solid/fine-stranded
Wire range (max.)	35 mm <sup>2</sup> stranded/25 mm <sup>2</sup> fine-stranded
Mounted on DIN rail acc. to EN 60715	35 mm
Housing material	Thermoplast, UL 94 V-0
Degree of protection	IP 20
Dimensions	4 TE, DIN 43880 (72 mm)
FM contacts / contact form	Change-over contact
Switching capacity AC (FM)	250 V/0.5 A
Switching capacity DC (FM)	250 V/0.1 A; 125 V/0.2 A; 75 V/0.5 A
Wire range remote signaling terminals	max. 1.5 mm <sup>2</sup> solid/fine-stranded
Approvals	CE

# 3-phase AC overvoltage arrester, type 2

## wietap G M TNS 275 (FM) For the protection of sub-systems or the control cabinet supply

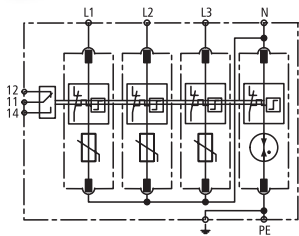

- Surge arrester, type 2
- For TT- and TN-S-systems ("3+1" circuits)
- With pluggable protection modules
- Function/failure indication according to VDE 0100-534 (valid since March 2009)
- Optional with remote signaling contact
- Vibration and shock tested acc. to EN 60068-2

Type	Part No.
<b>wietap G M TT 275 FM</b>	84.995.2315.0
<b>Replacement module</b>	
L1, L2, L3 against N	84.995.2010.0
N against $\varnothing$	84.995.2050.0
Power network	TT and TN-S (Variante "3+1")
SPD accord. to EN 61643-11	Type 2
SPD accord. to IEC 61643-1	Class II
Nominal voltage AC [U <sub>N</sub> ]	230/400 V
Nominal frequency [f <sub>N</sub> ]	50 / 60 Hz
Maximum continuous voltage AC [L-N] [U <sub>c</sub> ]	275 V
Maximum continuous voltage AC [N-PE] [U <sub>c</sub> ]	255 V
Nominal discharge current (8/20) [I <sub>n</sub> ]	20 kA
Max. discharge current (8/20) [I <sub>max</sub> ]	40 kA
Lightn. impulse current (10/350) [N-PE] [I <sub>imp</sub> ]	12 kA
Protection level [L-N] [U <sub>p</sub> ]	≤ 1.25 kV
Protection level [L-N] bei 5 kA [U <sub>p</sub> ]	≤ 1 kV
Protection level [N-PE] [U <sub>p</sub> ]	≤ 1.5 kV
Follow current extinction capability [N-PE] [I <sub>eff</sub> ]	100 A <sub>eff</sub>
Operating time [L-N] [t <sub>Δ</sub> ]	≤ 25 ns
Operating time [N-PE] [t <sub>Δ</sub> ]	≤ 100 ns
Maximum network overcurrent protection	125 A gL/gG
Short-circuit proof for maximum network current protection	up to 50 kA <sub>eff</sub>
TOV-voltage [L-N] [U <sub>T</sub> ]	335 V / 5 sec.
TOV-voltage [N-PE] [U <sub>T</sub> ]	1200 V / 200 ms
Temperature range [T <sub>U</sub> ]	-40 °C...+80 °C
Function/failure indication	green / red
Wire range (min.)	1.5 mm <sup>2</sup> solid/fine-stranded
Wire range (max.)	35 mm <sup>2</sup> stranded/25 mm <sup>2</sup> fine-stranded
Mounted on DIN rail acc. to EN 60715	35 mm
Housing material	Thermoplast, UL 94 V-0
Degree of protection	IP 20
Dimensions	4 TE, DIN 43880 (72 mm)
FM contacts / contact form	Change-over contact
Switching capacity AC (FM)	250 V/0.5 A
Switching capacity DC (FM)	250 V/0.1 A; 125 V/0.2 A; 75 V/0.5 A
Wire range remote signaling terminals	max. 1.5 mm <sup>2</sup> solid/fine-stranded
Approvals	CE

## Replacement module for wietap G M devices

### wietap G MOD 275

Varistor protection module  
for all L -  $\varnothing$ ; L - N  
and  
wietap G M TNS 275 (FM)  
N -  $\varnothing$



### wietap G MOD NPE

Spark gap protection module  
for all N -  $\varnothing$   
and  
wietap G M TT 275 (FM)  
N -  $\varnothing$



Type	Part No.
<b>wietap G MOD 275</b>	84.995.2010.0
<b>wietap G MOD NPE</b>	84.995.2050.0







# wienet VPN Industrial Router – unlimited M2M communication

## Functionality which convinces

Whether it is about the control of machines, monitoring of production lines or the co-ordination of all production areas a permanent communication between devices is needed to complete such a complex task. Access to stored data using wireless networks is not always possible or safe. Now Wieland offers with its modern router technology the possibility of completing such complex tasks. For example control commands, level indicators or video signals can now be transmitted. At download speeds of up to 100 Mbit/s and upload speeds of up to 50 Mbit/s (depending on the network operator) the **wienet** VPN industrial router is sure to cover the available connectivity options of GPRS up to LTE. With automatic login **wienet** VPN industrial router will always access the fastest available connection.

Each router has its own IP address and can be configured through the integrated web interface.

It supports services such as DHCP, NAT and DynDNS. The routers communicate directly or via the control panel to open a secure VPN connection. The establishment of an IPSec encrypted tunnel is alternatively possible. **wienet** VPN routers are ideal components for industrial use in conjunction with VPN-service portals, such as Wie-Service24.

With the arrangement of the ports on the front-panel and a standard USB port, the **wienet** VPN industrial router are extremely user friendly. A clear statistic of mobile connections is used for better control. Optionally, the devices are available with a second SIM card slot, additional I/O, RS-232, RS-422/RS-485, M-Bus, second Ethernet interface, Wi-Fi module or integrated 3 port switch.

## Applications

- Energy systems
  - Wind turbines
  - Solar farms
  - Biogas cogeneration systems
  - Heat pumps, ...
- Water and waste water Management
- System monitoring in machine building
  - Washing machines
  - Packaging machines
  - Compressors, ...
- External surveillance camera
- Vending
  - Telemetry online sales or ticket machines
- Smart metering
- Mobile Fleet Management



Further information on the complete product range can be found in the catalog

0800.1 "interface – solutions for the control cabinet"

and the products can also be found online via our e-catalog, which also provides more information, drawings, etc.



# VPN-Server „Wie-Service24“

## Additional VPN channels to VPN-server Wie-Service24

- Rent of additional VPN-tunnels to VPN-Server of Wieland Electric
- High availability of VPN connections
- Immediately usable
- Client access on the server



Type		Part No.
<b>wienet WIE-SERVICE24-EINZEL-R</b>	VPN-Router-Client	ZD.000.0011.0
<b>wienet WIE-SERVICE24-EINZEL-PC</b>	VPN-PC-Client	ZD.000.0011.1
<b>Properties</b>		
Security by VPN		
Automatic generation of router configurations		
Only outgoing connections to the VPN server Wie-Service24		
No changes in the local network needed		
Connection complete networks without additional route settings		
<b>Contract data</b>		
Calculation	12 months in advance	
Termination	any time at the end of a month	
Administration	Wieland Electric	
Server hardware	Internet high-performance computing center	

## Customer installation of the VPN server Wie-Service24

- Customer installation of the VPN server
- Administration on customer side
- High availability of VPN connections
- Customized layout possible



Type	Installation	Part No.
<b>wienet WIESERVICE24-VM</b>	Virtual machine "Oracle Virtual Box"	ZD.000.0012.0
<b>wienet WIESERVICE24-IPC SAVE</b>	On energy-saving PC hardware	ZD.000.0013.0
<b>wienet WIESERVICE24-IPC HIGH</b>	On High Performance 19 "PC	ZD.000.0014.0
<b>wienet WIESERVICE24-DC CUSTOM</b>	In customer data center	ZD.000.0015.0
<b>wienet WIESERVICE24-DC INTERN.</b>	In internet data center ("in the cloud")	ZD.000.0016.0
<b>Properties</b>		
Security by VPN		
Automatic generation of router configurations		
Only outgoing connections to the VPN server Wie-Service24		
No changes in the local network needed		
Connection complete networks without additional route settings		
<b>Contract data</b>		
Calculation	Fixed rate	
Number of VPN connections	> 1000	
Administration	customer	
Server hardware	selectable	

## Wie-Service24 VPN Service Portal All machines online!

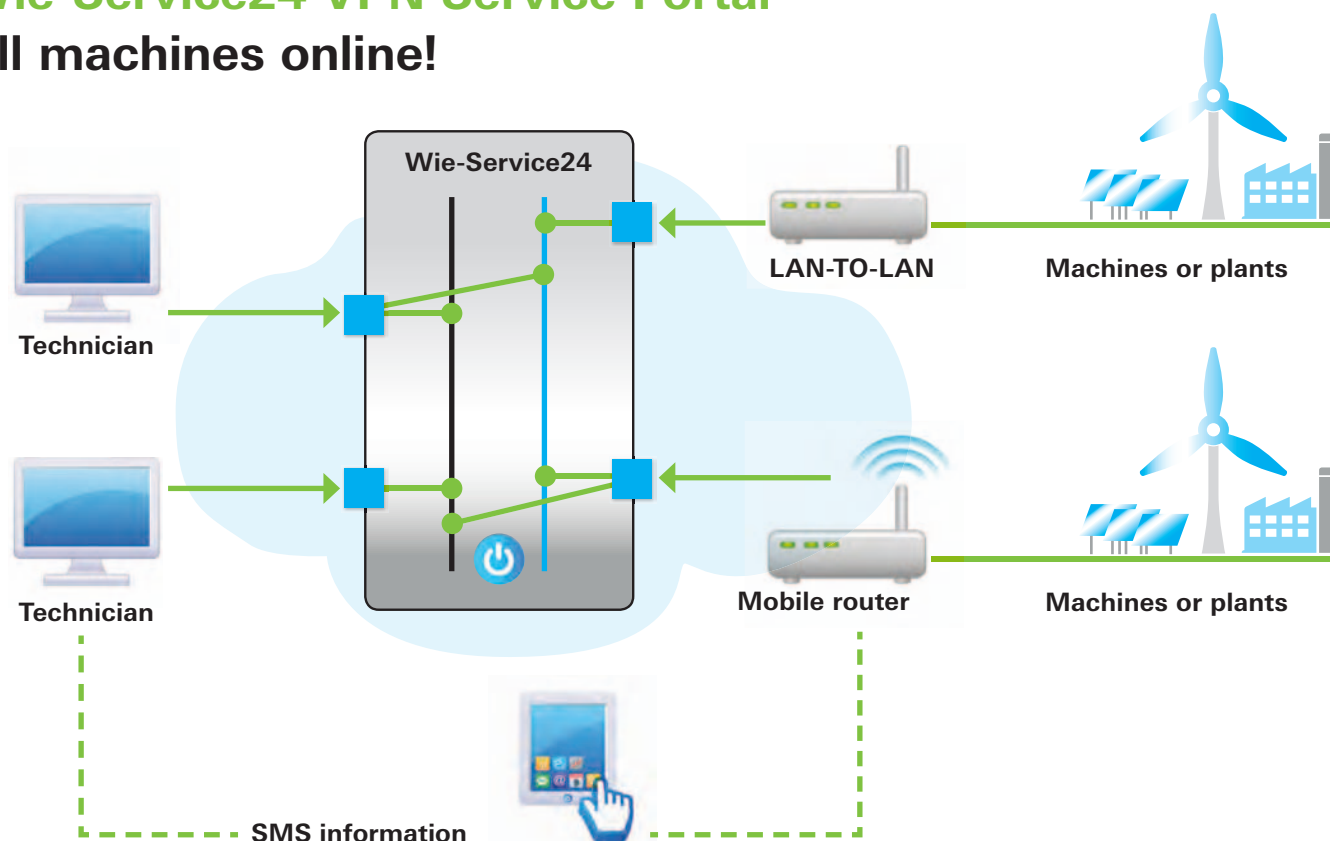

**The Wie-Service24 VPN service portal is available in different configurations:**

You can try the working with the VPN-server Wie-Service24 with up to 30 routers and one PC client for free. If you need further VPN clients you can rent more router and PC clients. We propose the installation of your own customer VPN server portal. Installation of the portal on a virtual machine, on an industrial PC, data center at customer site or a data center on an internet server.

	Single access	Virtual machine	Industrial PC	Data center Server at Customer	Data center Internet server
Part-No.	ZD.000.0011.0 (Router) ZD.000.0011.1 (PC-Client)	ZD.000.0012.0	ZD.000.0013.0 (Energy Saving) ZD.000.0014.0 (High Performance)	ZD.000.0015.0	ZD.000.0016.0
User access	•	•	•	•	•
Administrator access	–	•	•	•	•
Server hardware from	Wieland	Customer	Wieland	Customer	Provider
Internet connection by	Wieland	Customer	Customer	Customer	Provider
Installation by	Wieland	Customer or Wieland	Wieland	Wieland	Wieland



**More information is available from our technical support:**

Telefon +49 951 9324-995  
 Telefax +49 951 9326-991  
 wie-service24@wieland-electric.com



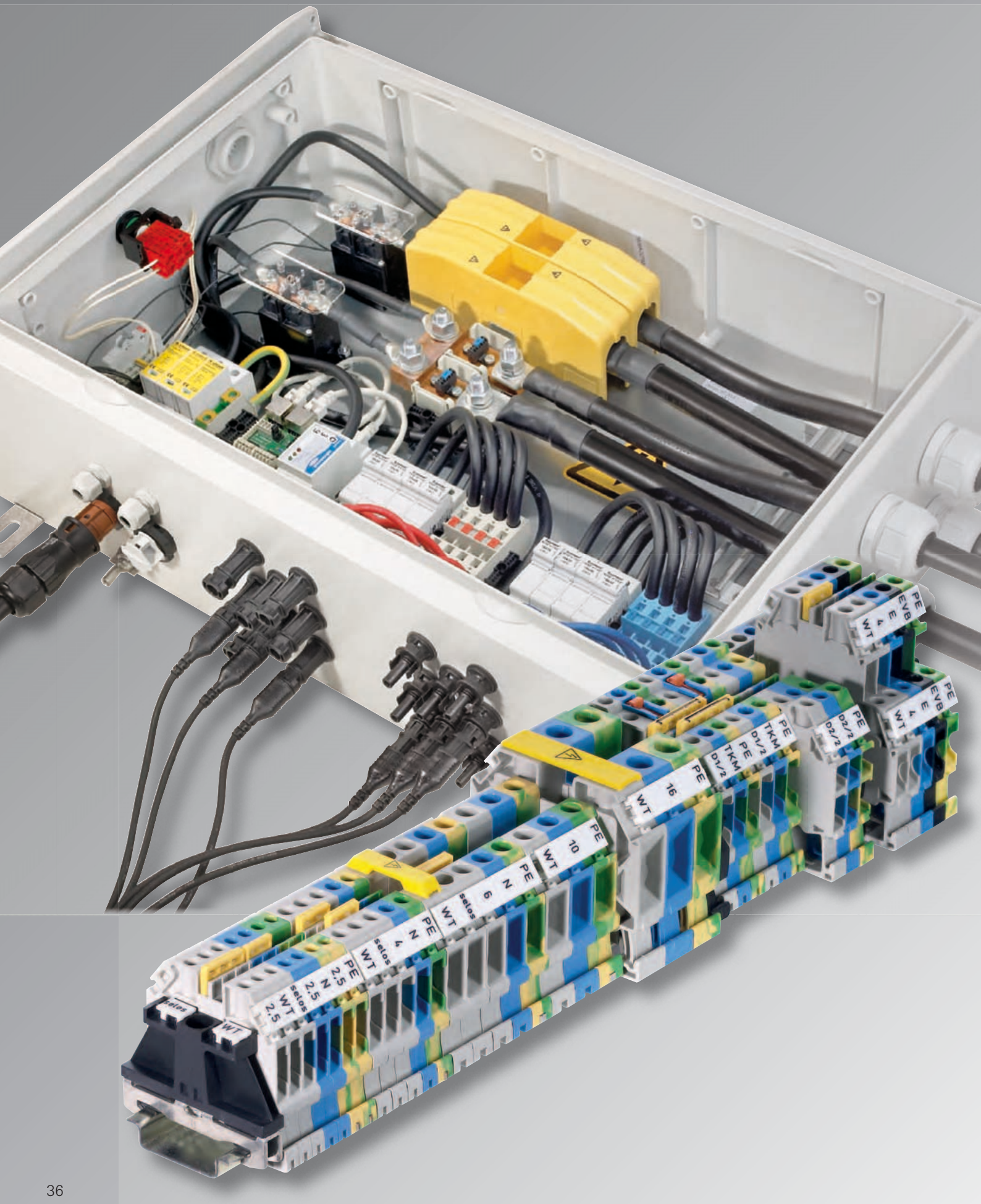



# DIN rail terminal blocks with screw connection

## Application example

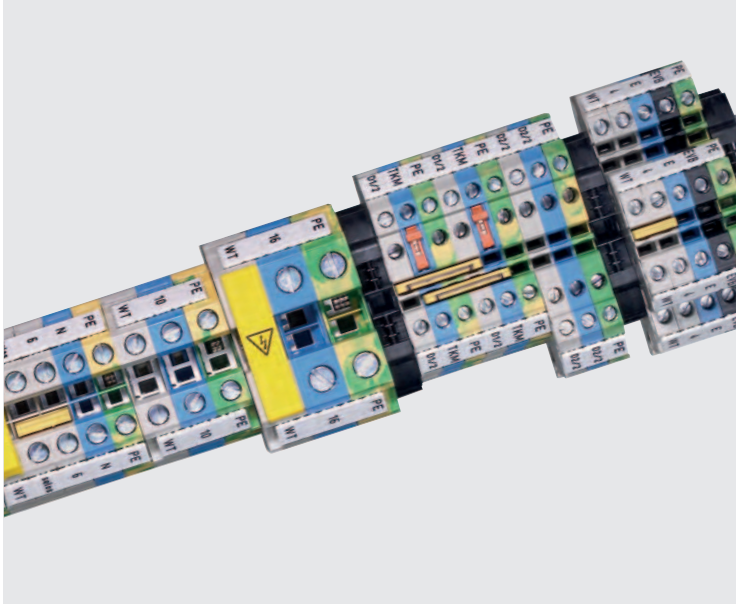

## Accessories

We offer a comprehensive assortment of various accessories for our screw connection **selos** screw connection terminal block range to customize our DIN rail terminal blocks to the requirements of your application. Among others it includes the proven Wieland marking system, which is also used for our other product lines, as well as our robust pluggable cross connectors.

In addition to various test accessories Wieland standard products also include end plates, partitions or special supplementary covers with warning symbols.

With our software systems **wieplan** and **wiemarc** we support you in designing and marking your DIN rail terminal block applications.

## Technical Data

Rated cross section:	2.5 mm <sup>2</sup> – 240 mm <sup>2</sup>
Rated current:	up to 415 A
Rated voltage:	up to 1000 V

### Selected material:

- **Metal** – Special alloys enable a low feed-through resistance and provide a gas-tight contact area:
  - Current carrying bar: copper or brass
  - Clamping body and clamping screws: steel, zinc-plated and chromate-treated
- **Plastic** – Polyamide has excellent electrical, chemical and mechanical characteristics:
  - Temperature resistance: up to 120 °C
  - Tracking resistance: CTI 600
  - Flammability class: UL94-V0, self-extinguishing

## General

With **selos** Wieland Electric offers a complete range of DIN rail terminal blocks with screw connection technology. Generously dimensioned wire entries, low feed-through resistance and a high dielectric strength make DIN rail terminal blocks from Wieland an optimal solution for connections in photovoltaic applications. The portfolio comprises feed-through and ground blocks with 2, 3 or 4 wire termination points, two-tier and three-tier terminal blocks, knife-edge disconnect blocks and fuse blocks. Furthermore we offer function blocks with various diode circuits as well as several application-specific terminal blocks such as terminal blocks for electrical isolation.



## Wieland DIN rail terminal blocks with screw connection highlights:

### Classic connections

- Known and proven worldwide, the simplest form of termination technology
- Space-saving, compact design with lateral wire entry
- Safe and maintenance-free electrical connection with maximum contact force

### Universal connections

- Flexible connection of various wire sizes due to the termination points' large wire ranges
- Multiple conductor termination in single clamping body facilitates potential distribution
- Connection of fine-stranded wires with and without ferrules
- Low feed-through resistance owing to large contact areas and high contact forces

### Versatile applications

- DIN rail terminal block solutions for all common switching tasks and functions
- Special-purpose blocks for industry-specific applications
- Comprehensive range of accessories for maximum functionality
- Global and national approvals for worldwide use

# Feed-through blocks with screw connection

## WT 2,5

- Feed-through block with screw connection for mounting on TS 35
- Nominal cross section 2.5 mm<sup>2</sup>
- Max. electrical data: 32 A/4 mm<sup>2</sup>
- Connection capacity: 2 wires, equal size 0.14 – 1.5 mm<sup>2</sup>

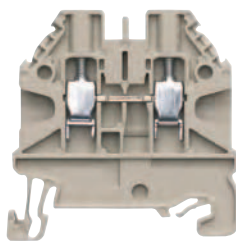

Description	Type	Part No.	Std. Pack
Feed-through block, gray	WT 2,5	58.503.0055.0	100
Feed-through block, blue	WT 2,5 BL	58.503.0055.6	100
<b>General data</b>			
Width / length / height, incl. TS 7.5	5 mm / 48 mm / 48 mm		
Wire strip length	9 mm		
Approvals			
<b>Technical data</b>	<b>IEC</b>	<b>UL</b>	<b>CSA</b>
	EN 60 947-7-1		
Cross section fine-stranded	0.14–4 mm <sup>2</sup>		pending
Cross section solid/stranded	0.14–4 mm <sup>2</sup>		
Cross section, AWG		26–12	26–12
Rated current	24 A	20 A	20 A
Rated voltage	1000 V	600 V	600 V
Rated impulse voltage	8 kV		
Pollution degree	3		
<b>Accessories</b>			
End plate	AP WT 2,5-10	07.313.2555.0	10
Cross connector	2 pole IVB WKF 2,5-2	Z7.280.6227.0	10
	3 pole IVB WKF 2,5-3	Z7.280.6327.0	10
	4 pole IVB WKF 2,5-4	Z7.280.6427.0	10
	5 pole IVB WKF 2,5-5	Z7.280.6527.0	10
	10 pole IVB WKF 2,5-10	Z7.280.7027.0	20
	20 pole IVB WKF 2,5-20	Z7.280.8027.0	20

## WT 4

- Feed-through block with screw connection for mounting on TS 35
- Nominal cross section 4 mm<sup>2</sup>
- Max. electrical data: 41 A/6 mm<sup>2</sup>
- Connection capacity: 2 wires, equal size 0.14 – 2.5 mm<sup>2</sup>

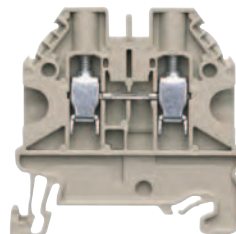

Description	Type	Part No.	Std. Pack
Feed-through block, gray	WT 4	58.504.0055.0	100
Feed-through block, blue	WT 4 BL	58.504.0055.6	100
<b>General data</b>			
Width / length / height, incl. TS 7.5	6 mm / 48 mm / 48 mm		
Wire strip length	9 mm		
Approvals			
<b>Technical data</b>	<b>IEC</b>	<b>UL</b>	<b>CSA</b>
	EN 60 947-7-1		
Cross section fine-stranded	0.14–6 mm <sup>2</sup>		pending
Cross section solid/stranded	0.14–6 mm <sup>2</sup>		
Cross section, AWG		26–10	26–10
Rated current	32 A	30 A	30 A
Rated voltage	1000 V	600 V	600 V
Rated impulse voltage	8 kV		
Pollution degree	3		
<b>Accessories</b>			
End plate	AP WT 2,5-10	07.313.2555.0	10
Cross connector	2 pole IVB WKF 4-2	Z7.261.1227.0	10
	3 pole IVB WKF 4-3	Z7.261.1327.0	10
	4 pole IVB WKF 4-4	Z7.261.1427.0	10
	5 pole IVB WKF 4-5	Z7.261.1527.0	10
	10 pole IVB WKF 4-10	Z7.261.2027.0	20

## WT 6

- Feed-through block with screw connection for mounting on TS 35
- Nominal cross section 6 mm<sup>2</sup>
- Max. electrical data: 57 A/10 mm<sup>2</sup>
- Connection capacity: 2 wires, equal size 0.2 – 4 mm<sup>2</sup>

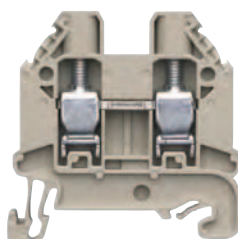

Description	Type	Part No.	Std. Pack
Feed-through block, gray	WT 6	58.506.0055.0	100
Feed-through block, blue	WT 6 BL	58.506.0055.6	100
<b>General data</b>			
Width / length / height, incl. TS 7.5	8 mm / 48 mm / 48 mm		
Wire strip length	11 mm		
Approvals			
<b>Technical data</b>	<b>IEC</b>	<b>UL</b>	<b>CSA</b>
	EN 60 947-7-1		
Cross section fine-stranded	0.2–10 mm <sup>2</sup>		pending
Cross section solid/stranded	0.2–10 mm <sup>2</sup>		
Cross section, AWG		24–8	24–8
Rated current	41 A	50 A	50 A
Rated voltage	1000 V	600 V	600 V
Rated impulse voltage	8 kV		
Pollution degree	3		
<b>Accessories</b>			
End plate	AP WT 2,5-10	07.313.2555.0	10
Cross connector	2 pole IVB WKF 6-2	Z7.282.5227.0	10
	3 pole IVB WKF 6-3	Z7.282.5327.0	10
	4 pole IVB WKF 6-4	Z7.282.5427.0	10
	5 pole IVB WKF 6-5	Z7.282.5527.0	10
	10 pole IVB WKF 6-10	Z7.282.6027.0	10

# Feed-through blocks with screw connection

## WT 10

- Feed-through block with screw connection for mounting on TS 35
- Nominal cross section 10 mm<sup>2</sup>
- Max. electrical data: 76 A / 16 mm<sup>2</sup>
- Connection capacity: 2 wires, equal size 0.5 – 6 mm<sup>2</sup>

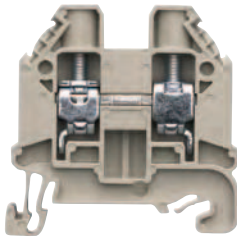

Description	Type	Part No.	Std. Pack
Feed-through block, gray	WT 10	58.510.0055.0	50
Feed-through block, blue	WT 10 BL	58.510.0055.6	50
<b>General data</b>			
Width / length / height, incl. TS 7.5	10 mm / 48 mm / 48 mm		
Wire strip length	13 mm		
Approvals			
<b>Technical data</b>			
	<b>IEC</b>	<b>UL</b>	<b>CSA</b>
	EN 60 947-7-1		
Cross section fine-stranded	0.5 – 16 mm <sup>2</sup>		pending
Cross section solid/stranded	0.5 – 16 mm <sup>2</sup>		
Cross section, AWG		20 – 6	20 – 6
Rated current	57 A	65 A	65 A
Rated voltage	1000 V	600 V	600 V
Rated impulse voltage	8 kV		
Pollution degree	3		
<b>Accessories</b>			
	Type	Part No.	Std. Pack
End plate	AP WT 2,5-10	07.313.2555.0	10
Cross connector	2 pole IVB WKF 10-2	Z7.283.8227.0	10

## WT 16

- Feed-through block with screw connection for mounting on TS 35
- Nominal cross section 16 mm<sup>2</sup>
- Max. electrical data: 101 A / 25 mm<sup>2</sup>
- Connection capacity: 2 wires, equal size 2.5 – 10 mm<sup>2</sup>

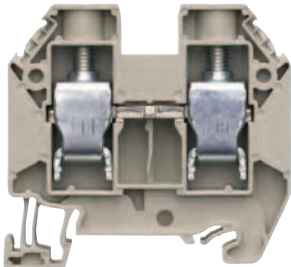

Description	Type	Part No.	Std. Pack
Feed-through block, gray	WT 16	58.516.0055.0	50
Feed-through block, blue	WT 16 BLAU	58.516.0055.6	50
<b>General data</b>			
Width / length / height, incl. TS 7.5	12 mm / 58 mm / 54mm		
Wire strip length	15 mm		
Approvals			
<b>Technical data</b>			
	<b>IEC</b>	<b>UL</b>	<b>CSA</b>
	EN 60 947-7-1		
Cross section fine-stranded	4 – 25 mm <sup>2</sup>		pending
Cross section solid/stranded	1.5 – 25 mm <sup>2</sup>		
Cross section, AWG		16 – 4	16 – 4
Rated current	76 A	85 A	85 A
Rated voltage	1000 V	600 V	600 V
Rated impulse voltage	8 kV		
Pollution degree	3		
<b>Accessories</b>			
	Type	Part No.	Std. Pack
End plate	AP WT 16	07.313.2755.0	10
Cross connector	2 pole IVB WKF 16-2	Z7.284.4227.0	10

## Accessories for *selos* WT 2,5 – WT 16

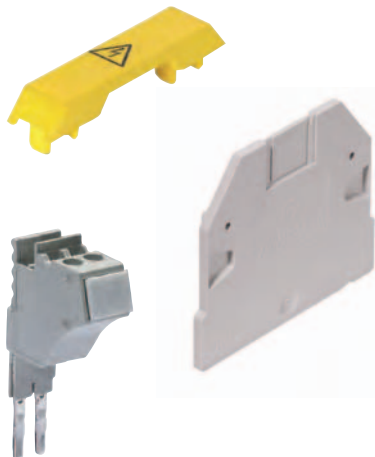

Accessories	Type	Part No.	Std. Pack
Cover with warning symbol	for WT 2,5	AD WT 2,5	04.344.1455.8
	for WT 4	AD WT 4	04.344.1655.8
	for WT 6	AD WT 6/10	04.344.1855.8
	for WT 10	AD WT 6/10	04.344.1855.8
	for WT 16	AD WT 16	04.344.2255.8
Partition for WT 2,5 – WT 10	TW WT 2,5-10	07.313.2655.0	10
Partition for WT 16	TW WT 4E	07.313.2855.0	10
Test adapter modular for WT 2,5 and 4	PS WKC/F	Z1.299.9753.0	10
End plate for test adapter *	ZP/AP PS	07.312.6053.0	10

\* for WT4 an end cover plate must be snapped in after each test connector





# Ground blocks with screw connection

## WT 2,5 PE

- Ground block with screw connection for mounting on TS 35
- Nominal cross section 2.5 mm<sup>2</sup>
- Connection capacity: 2 wires, equal size 0.14 – 1.5 mm<sup>2</sup>

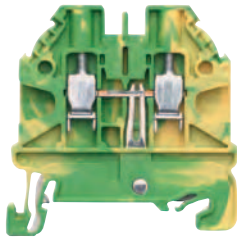

Description	Type	Part No.	Std. Pack
Ground block, green/yellow	WT 2,5 PE	58.503.9055.0	100
<b>General data</b>			
Width / length / height, incl. TS 7.5	5 mm / 48 mm / 48 mm		
Wire strip length	9 mm		
Approvals			
<b>Technical data</b>	<b>IEC</b>	<b>UL</b>	<b>CSA</b>
	EN 60 94-7-2		
Cross section fine-stranded	0.14–4 mm <sup>2</sup>		pending
Cross section solid/stranded	0.14–4 mm <sup>2</sup>		
Cross section, AWG		26–12	26–12
Rated current			
Rated voltage	1000 V	600 V	600 V
Rated impulse voltage	8 kV		
Pollution degree	3		
<b>Accessories</b>			
	Type	Part No.	Std. Pack
End plate	AP WT 2,5 - 10	07.313.2555.0	10

## WT 4 PE

- Ground block with screw connection for mounting on TS 35
- Nominal cross section 4 mm<sup>2</sup>
- Connection capacity: 2 wires, equal size 0.14 – 2.5 mm<sup>2</sup>

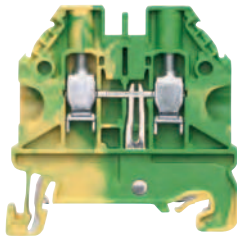

Description	Type	Part No.	Std. Pack
Ground block, green/yellow	WT 4 PE	58.504.9055.0	100
<b>General data</b>			
Width / length / height, incl. TS 7.5	6 mm / 48 mm / 48 mm		
Wire strip length	9 mm		
Approvals			
<b>Technical data</b>	<b>IEC</b>	<b>UL</b>	<b>CSA</b>
	EN 60 94-7-2		
Cross section fine-stranded	0.14–6 mm <sup>2</sup>		pending
Cross section solid/stranded	0.14–6 mm <sup>2</sup>		
Cross section, AWG		26–10	26–10
Rated current			
Rated voltage	1000 V	600 V	600 V
Rated impulse voltage	8 kV		
Pollution degree	3		
<b>Accessories</b>			
	Type	Part No.	Std. Pack
End plate	AP WT 2,5 - 10	07.313.2555.0	10

## WT 6 PE

- Ground block with screw connection for mounting on TS 35
- Nominal cross section 6 mm<sup>2</sup>
- Connection capacity: 2 wires, equal size 0.2 – 4 mm<sup>2</sup>

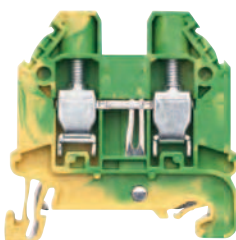

Description	Type	Part No.	Std. Pack
Ground block, green/yellow	WT 6 PE	58.506.9055.0	100
<b>General data</b>			
Width / length / height, incl. TS 7.5	8 mm / 48 mm / 48 mm		
Wire strip length	11 mm		
Approvals			
<b>Technical data</b>	<b>IEC</b>	<b>UL</b>	<b>CSA</b>
	EN 60 94-7-2		
Cross section fine-stranded	0.2–10 mm <sup>2</sup>		pending
Cross section solid/stranded	0.2–10 mm <sup>2</sup>		
Cross section, AWG		24–8	24–8
Rated current			
Rated voltage	1000 V	600 V	600 V
Rated impulse voltage	8 kV		
Pollution degree	3		
<b>Accessories</b>			
	Type	Part No.	Std. Pack
End plate	AP WT 2,5 - 10	07.313.2555.0	10

# Ground blocks with screw connection

## WT 10 PE

- Ground block with screw connection for mounting on TS 35
- Nominal cross section 10 mm<sup>2</sup>
- Connection capacity: 2 wires, equal size 0.5 – 6 mm<sup>2</sup>

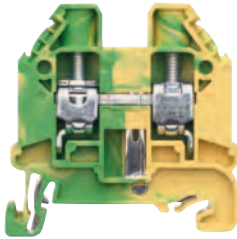

Description	Type	Part No.	Std. Pack
Ground block, green/yellow	WT 10 PE	58.510.9055.0	50
<b>General data</b>			
Width / length / height, incl. TS 7.5	10 mm / 48 mm / 48 mm		
Wire strip length	13 mm		
Approvals			
<b>Technical data</b>	<b>IEC</b>	<b>UL</b>	<b>CSA</b>
	EN 60 94-7-2		
Cross section fine-stranded	0.5 – 16 mm <sup>2</sup>		
Cross section solid/stranded	0.5 – 16 mm <sup>2</sup>		
Cross section, AWG		20 – 6	20 – 6
Rated current			pending
Rated voltage	1000 V	600 V	600 V
Rated impulse voltage	8 kV		
Pollution degree	3		
<b>Accessories</b>			
	Type	Part No.	Std. Pack
End plate	AP WT 2,5 - 10	07.313.2555.0	10

## WT 16 PE

- Ground block with screw connection for mounting on TS 35
- Nominal cross section 16 mm<sup>2</sup>
- Connection capacity: 2 wires, equal size 2.5 – 10 mm<sup>2</sup>

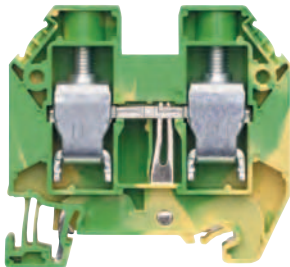

Description	Type	Part No.	Std. Pack
Ground block, green/yellow	WT 16 PE	58.516.9055.0	100
<b>General data</b>			
Width / length / height, incl. TS 7.5	12 mm / 58 mm / 54 mm		
Wire strip length	15 mm		
Approvals			
<b>Technical data</b>	<b>IEC</b>	<b>UL</b>	<b>CSA</b>
	EN 60 94-7-2		
Cross section fine-stranded	4 – 25 mm <sup>2</sup>		
Cross section solid/stranded	1.5 – 25 mm <sup>2</sup>		
Cross section, AWG		16 – 4	16 – 4
Rated current			pending
Rated voltage	1000 V	600 V	600 V
Rated impulse voltage	8 kV		
Pollution degree	3		
<b>Accessories</b>			
	Type	Part No.	Std. Pack
End plate	AP WT 16	07.313.2755.0	10



# DIN rail terminal blocks with screw connection, type 9700 A.. S35

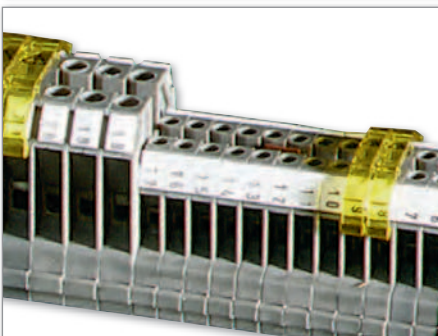
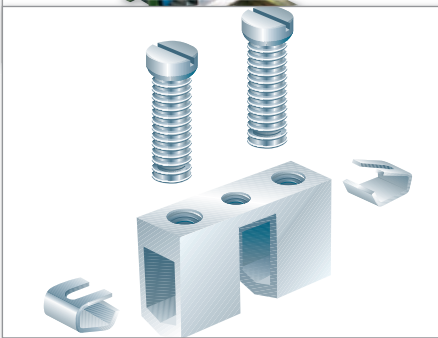
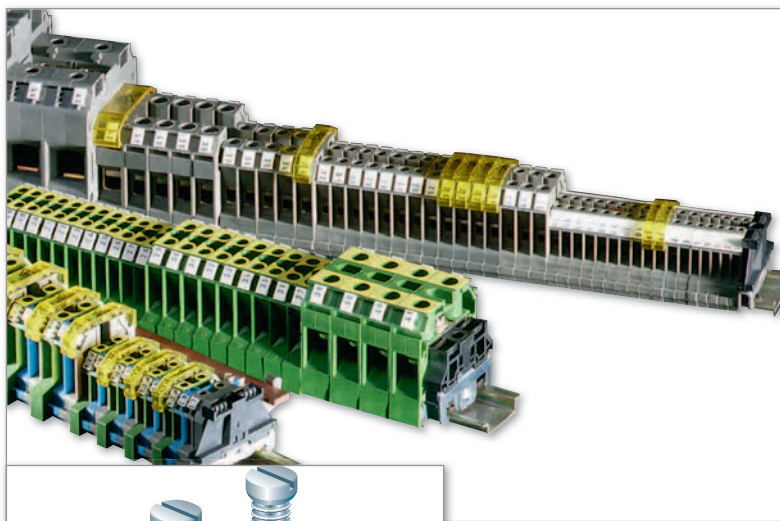

## DIN rail terminal blocks with screw connection – **selos** CLASSIC

The **selos** CLASSIC series offers the highest-quality connecting technology. Thanks to its unique clamping body design, aluminum or copper wire connections are long lasting and maintenance-free.

The product line includes feed-through and ground blocks for wires up to 50 mm<sup>2</sup>.

### High-quality screw connection technology

- Steel free clamping body
  - Increased corrosion resistance
  - Extruded clamping body, nickel-plated brass
- Low contact resistance
  - Clamping body has similar physical and chemical characteristics as the conductor
  - One piece clamping body/current bar

### Connection of aluminum wires possible

The following always applies when connecting aluminium wires in the **selos** CLASSIC LINE:

- After being stripped, the ends of the wires must be cleaned with a brush and then coated with acid-free grease to prevent further oxidation.
- The terminal should be tightened to approx. 20% higher torque than what is stated for the clamping screw.

With this type of terminal, it is not necessary to retighten the clamping screws.

### Wide connection range

- Connection range 0.5 – 50 mm<sup>2</sup>  
Solid, fine-stranded and stranded wires can be connected to the terminal blocks of **selos** CLASSIC LINE without ferrules, as all block sizes have wire protection.

### Compact design

- **Save space on the rail**
  - **selos** CLASSIC LINE offers higher density due to the wire size and terminal block pitch:

Connection range	Pitch
2,5 mm <sup>2</sup>	5 mm
4 mm <sup>2</sup>	6 mm
10 mm <sup>2</sup>	8 mm
16 mm <sup>2</sup>	10 mm
25 mm <sup>2</sup>	12 mm
35 mm <sup>2</sup>	16 mm



# Feed-through blocks with screw connection, type 9700 A.. S35

## 9700 A/5 S35

- Feed-through block for mounting on TS 35
- Nominal cross section 2.5 mm<sup>2</sup>

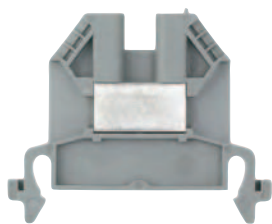

Description	Type	Part No.	Std. Pack
Feed-through block, gray	9700 A/5 S35	54.003.7553.0	100
Feed-through block, (Ex)i, blue	9700 A/5 S35 BLAU	54.003.7553.6	100
<b>General data</b>			
Width / length / height, incl. TS 7.5	5 mm / 47 mm / 38 mm		
Wire strip length	9 mm		
Approvals			
<b>Technical data</b>			
	<b>IEC</b>	<b>UL</b>	<b>CSA</b>
Ratings for use of insulating sleeves	EN 60 947-7-1		
Cross section fine-stranded	0.5 – 2.5 mm <sup>2</sup>		
Cross section solid/stranded	0.5 – 4 mm <sup>2</sup>		
Cross section, AWG		18 – 12	22 – 12
Rated current	24 A	20/30 A	25 A
Rated voltage	800 V	600 V	600 V
Rated impulse voltage	8 kV		
Pollution degree	3		
<b>Accessories</b>			
	Type	Part No.	Std. Pack
End plate, gray	9701/6	07.310.3153.0	10
Partition, gray	9702/6	07.310.3453.0	10
Cross connector with screws, 2 pole	9703/5-2	Z7.215.0227.0	50
E-Cu, uninsulated	3 pole	9703/5-3	Z7.215.0327.0
	4 pole	9703/5-4	Z7.215.0427.0
	5 pole	9703/5-5	Z7.215.0527.0
	6 pole	9703/5-6	Z7.215.0627.0
Cut-to-order strip 0,6 m long	9703/5-M	Z7.215.0027.0	10
2-pole switchable jumper		Z7.269.3523.0	50
Adapter for test plug	9011 D	05.508.8921.0	10
Cover with warn. symbol for 1 block	yellow	04.325.1656.0	10

## 9700 A/6 S35

- Feed-through block for mounting on TS 35
- Nominal cross section 4 mm<sup>2</sup>



Description	Type	Part No.	Std. Pack
Feed-through block, gray	9700 A/6 S35	54.004.7553.0	100
Feed-through block, (Ex)i, blue	9700 A/6 S35 BLAU	54.004.7553.6	100
<b>General data</b>			
Width / length / height, incl. TS 7.5	6 mm / 47 mm / 38 mm		
Wire strip length	9 mm		
Approvals			
<b>Technical data</b>			
	<b>IEC</b>	<b>UL</b>	<b>CSA</b>
Ratings for use of insulating sleeves	EN 60 947-7-1		
Cross section fine-stranded	0.5 – 4 mm <sup>2</sup>		
Cross section solid/stranded	0.5 – 6 mm <sup>2</sup>		
Cross section, AWG		18 – 10	22 – 10
Rated current	32 A	30/30 A	35 A
Rated voltage	800 V	600 V	600 V
Rated impulse voltage	8 kV		
Pollution degree	3		
<b>Accessories</b>			
	Type	Part No.	Std. Pack
End plate, gray	9701/6	07.310.3153.0	10
Partition, gray	9702/6	07.310.3453.0	10
Cross connector with screws, 2 pole	9703/6-2	Z7.211.0227.0	50
E-Cu, uninsulated	3 pole	9703/6-3	Z7.211.0327.0
	4 pole	9703/6-4	Z7.211.0427.0
	5 pole	9703/6-5	Z7.211.0527.0
	6 pole	9703/6-6	Z7.211.0627.0
Cut-to-order strip 0,6 m long	9703/6-M	Z7.211.0027.0	10
2-pole switchable jumper		Z7.269.2923.0	50
Adapter for test plug	9011 C	05.508.8821.0	10
Cover with warn. symbol for 1 block	yellow	04.325.1056.0	10

# Feed-through blocks with screw connection, type 9700 A.. S35

## 9700 A/8 S35

- Feed-through block for mounting on TS 35
- Nominal cross section 16 mm<sup>2</sup>



Description	Type	Part No.	Std. Pack
Feed-through block, gray	9700 A/8 S 35	54.010.7553.0	100
Feed-through block, (Ex)i, blue	9700 A/8 S 35 BLAU	54.010.7553.6	100
<b>General data</b>			
Width / length / height, incl. TS 7.5	8 mm / 47 mm / 48 mm		
Wire strip length	12 mm		
Approvals			
<b>Technical data</b>	<b>IEC</b>	<b>UL</b>	<b>CSA</b>
	EN 60 947-7-1		
Cross section fine-stranded	1 – 10 mm <sup>2</sup>		
Cross section solid/stranded	1 – 10 mm <sup>2</sup>		
Cross section, AWG		18–8	18–8
Rated current	57 A	50/50 A	55 A
Rated voltage	800 V	600 V	600 V
Rated impulse voltage	8 kV		
Pollution degree	3		
<b>Accessories</b>			
End plate	gray 9701/8	07.310.3253.0	10
Partition	gray 9702/8	07.310.3553.0	10
Cross connector with screws, E-Cu, uninsulated	2 pole 9703/8-2	Z7.212.0227.0	50
	3 pole 9703/8-3	Z7.212.0327.0	50
	4 pole 9703/8-4	Z7.212.0427.0	50
	5 pole 9703/8-5	Z7.212.0527.0	50
	6 pole 9703/8-6	Z7.212.0627.0	50
2-pole switchable jumper		Z7.269.3023.0	50
Adapter for test plug	9011 B	05.508.3221.0	10
Cover with warn. symbol for 1 block	yellow	04.325.1156.0	10
Rapid mounting tool		05.593.5953.0	10

## 9700 A/10 S35

- Feed-through block for mounting on TS 35
- Nominal cross section 16 mm<sup>2</sup>



Description	Type	Part No.	Std. Pack
Feed-through block, gray	9700 A/10 S 35	54.016.7553.0	100
Feed-through block, (Ex)i, blue	9700 A/10 S 35 BLAU	54.016.7553.6	100
<b>General data</b>			
Width / length / height, incl. TS 7.5	10 mm / 49 mm / 51 mm		
Wire strip length	15 mm		
Approvals			
<b>Technical data</b>	<b>IEC</b>	<b>UL</b>	<b>CSA</b>
	EN 60 947-7-1		
Cross section fine-stranded	1.5 – 16 mm <sup>2</sup>		
Cross section solid/stranded	1.5 – 16 mm <sup>2</sup>		
Cross section, AWG		18–6	18–6
Rated current	76 A	65/70 A	70 A
Rated voltage	800 V	600 V	600 V
Rated impulse voltage	8 kV		
Pollution degree	3		
<b>Accessories</b>			
End plate	gray 9701/10	07.310.3953.0	10
Partition	gray 9702/10	07.310.4053.0	10
Cross connector with screws, E-Cu, uninsulated	2 pole 9703/10-2	Z7.214.0227.0	50
	3 pole 9703/10-3	Z7.214.0327.0	50
	4 pole 9703/10-4	Z7.214.0427.0	50
	5 pole 9703/10-5	Z7.214.0527.0	50
	6 pole 9703/10-6	Z7.214.0627.0	50
2-pole switchable jumper		Z7.269.3123.0	50
Adapter for test plug	9011 A	05.508.3121.0	10
Cover with warn. symbol for 1 block	yellow	04.325.1256.0	10

# Feed-through blocks with screw connection, type 9700 A.. S35

## 9700 A/12 S35

- Feed-through block for mounting on TS 35
- Nominal cross section 25 mm<sup>2</sup>

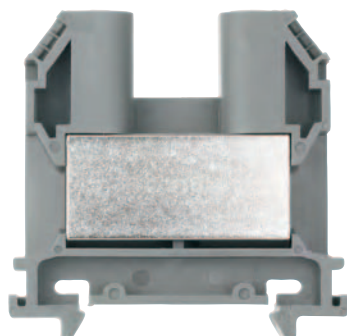

Description	Type	Part No.	Std. Pack
Feed-through block, gray	9700 A/12 S 35	54.025.7553.0	50
Feed-through block, (Ex)i, blue	9700 A/12 S 35 BLAU	54.025.7553.6	50
<b>General data</b>			
Width / length / height, incl. TS 7.5	12 mm / 59 mm / 58 mm		
Wire strip length	20 mm		
Approvals			
<b>Technical data</b>	<b>IEC</b>	<b>UL</b>	<b>CSA</b>
	EN 60 947-7-1		
Cross section fine-stranded	2.5 – 25 mm <sup>2</sup>		
Cross section solid/stranded	2.5 – 35 mm <sup>2</sup>		
Cross section, AWG		14–4	14–4
Rated current	101 A	85/100 A	100 A
Rated voltage	800 V	600 V	600 V
Rated impulse voltage	8 kV		
Pollution degree	3		
<b>Accessories</b>			
End plate	gray 9701/12	07.310.3353.0	10
Partition	gray 9702/12	07.310.3653.0	10
Cross connector with screws, E-Cu, uninsulated	2 pole 9703/12-2	Z7.213.0227.0	50
	3 pole 9703/12-3	Z7.213.0327.0	50
	4 pole 9703/12-4	Z7.213.0427.0	50
	5 pole 9703/12-5	Z7.213.0527.0	50
	6 pole 9703/12-6	Z7.213.0627.0	50
2-pole switchable jumper		Z7.269.3223.0	50
Adapter for test plug		05.508.6521.0	10
Cover with warn. symbol for 1 block	yellow	04.325.1356.0	10

## 9700 A/16 S35

- Feed-through block for mounting on TS 35
- Nominal cross section 35 mm<sup>2</sup>

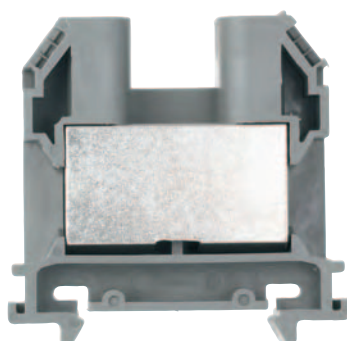

Description	Type	Part No.	Std. Pack
Feed-through block, gray	9700 A/16 S 35	54.035.7553.0	50
Feed-through block, (Ex)i, blue	9700 A/16 S 35 BLAU	54.035.7553.6	50
<b>General data</b>			
Width / length / height, incl. TS 7.5	16 mm / 59 mm / 58 mm		
Wire strip length	20 mm		
Approvals			
<b>Technical data</b>	<b>IEC</b>	<b>UL</b>	<b>CSA</b>
	EN 60 947-7-1		
Cross section fine-stranded	2,5 – 35 mm <sup>2</sup>		
Cross section solid/stranded	2,5 – 50 mm <sup>2</sup>		
Cross section, AWG		6–2	12–2
Rated current	125 A	115/130 A	125 A
Rated voltage	1000 V	600 V	600 V
Rated impulse voltage	8 kV		
Pollution degree	3		
<b>Accessories</b>			
End plate	gray 9701/12	07.310.3353.0	10
Partition	gray 9702/12	07.310.3653.0	10
Cross connector with screws, E-Cu, uninsulated	2 pole 9703/16-2	Z7.216.0227.0	50
	3 pole 9703/16-3	Z7.216.0327.0	50
	4 pole 9703/16-4	Z7.216.0427.0	50
	5 pole 9703/16-5	Z7.216.0527.0	50
	6 pole 9703/16-6	Z7.216.0627.0	50
2-pole switchable jumper		Z7.269.3423.0	50
Adapter for test plug		05.508.6521.0	10
Cover with warn. symbol for 1 block	yellow	04.325.1456.0	10





# High-current terminal blocks with screw connection

<p><b>RFK 1/95... S35</b></p>	<table border="1"> <thead> <tr> <th>Description</th> <th>Color</th> <th>Type</th> <th>Part No.</th> <th>Std. Pack</th> </tr> </thead> <tbody> <tr> <td><b>Configuration F</b></td> <td>gray</td> <td>RFK 1/95 F S35</td> <td>56.395.0055.0</td> <td>10</td> </tr> <tr> <td><b>Configuration K</b></td> <td>gray</td> <td>RFK 1/95 K S35</td> <td>56.395.0155.0</td> <td>10</td> </tr> <tr> <td><b>Configuration FK</b></td> <td>gray</td> <td>RFK 1/95 FK S35</td> <td>56.395.0255.0</td> <td>10</td> </tr> <tr> <td><b>Configuration FM</b></td> <td>gray</td> <td>RFK 1/95 FM S35</td> <td>56.395.1055.0</td> <td>10</td> </tr> <tr> <td><b>Configuration FMK</b></td> <td>gray</td> <td>RFK 1/95 FMK S35</td> <td>56.395.1255.0</td> <td>10</td> </tr> </tbody> </table> <table border="1"> <tbody> <tr> <td>DIN VDE 0611 sect. 1/EN 60 947-7-1</td> <td>fine-stranded</td> <td></td> <td>V</td> <td>A</td> </tr> <tr> <td>UL ratings</td> <td>field/factory wiring</td> <td>16 – 95 mm<sup>2</sup></td> <td>1000 V</td> <td>250</td> </tr> <tr> <td>CSA ratings</td> <td></td> <td>No. 6-3/0 AWG</td> <td>600 V</td> <td>200</td> </tr> <tr> <td>Width</td> <td>wire strip length</td> <td>32 mm</td> <td></td> <td>27 mm</td> </tr> <tr> <td>Approvals</td> <td colspan="4"> </td> </tr> </tbody> </table>	Description	Color	Type	Part No.	Std. Pack	<b>Configuration F</b>	gray	RFK 1/95 F S35	56.395.0055.0	10	<b>Configuration K</b>	gray	RFK 1/95 K S35	56.395.0155.0	10	<b>Configuration FK</b>	gray	RFK 1/95 FK S35	56.395.0255.0	10	<b>Configuration FM</b>	gray	RFK 1/95 FM S35	56.395.1055.0	10	<b>Configuration FMK</b>	gray	RFK 1/95 FMK S35	56.395.1255.0	10	DIN VDE 0611 sect. 1/EN 60 947-7-1	fine-stranded		V	A	UL ratings	field/factory wiring	16 – 95 mm <sup>2</sup>	1000 V	250	CSA ratings		No. 6-3/0 AWG	600 V	200	Width	wire strip length	32 mm		27 mm	Approvals				
Description	Color	Type	Part No.	Std. Pack																																																				
<b>Configuration F</b>	gray	RFK 1/95 F S35	56.395.0055.0	10																																																				
<b>Configuration K</b>	gray	RFK 1/95 K S35	56.395.0155.0	10																																																				
<b>Configuration FK</b>	gray	RFK 1/95 FK S35	56.395.0255.0	10																																																				
<b>Configuration FM</b>	gray	RFK 1/95 FM S35	56.395.1055.0	10																																																				
<b>Configuration FMK</b>	gray	RFK 1/95 FMK S35	56.395.1255.0	10																																																				
DIN VDE 0611 sect. 1/EN 60 947-7-1	fine-stranded		V	A																																																				
UL ratings	field/factory wiring	16 – 95 mm <sup>2</sup>	1000 V	250																																																				
CSA ratings		No. 6-3/0 AWG	600 V	200																																																				
Width	wire strip length	32 mm		27 mm																																																				
Approvals																																																								
<p><b>RFK 1/150... S35</b></p>	<table border="1"> <thead> <tr> <th>Description</th> <th>Color</th> <th>Type</th> <th>Part No.</th> <th>Std. Pack</th> </tr> </thead> <tbody> <tr> <td><b>Configuration F</b></td> <td>gray</td> <td>RFK 1/150 F S35</td> <td>56.397.0055.0</td> <td>10</td> </tr> <tr> <td><b>Configuration K</b></td> <td>gray</td> <td>RFK 1/150 K S35</td> <td>56.397.0155.0</td> <td>10</td> </tr> <tr> <td><b>Configuration FK</b></td> <td>gray</td> <td>RFK 1/150 FK S35</td> <td>56.397.0255.0</td> <td>10</td> </tr> <tr> <td><b>Configuration FMK</b></td> <td>gray</td> <td>RFK 1/150 FMK S35</td> <td>56.397.1255.0</td> <td>10</td> </tr> </tbody> </table> <table border="1"> <tbody> <tr> <td>DIN VDE 0611 sect. 1/EN 60 947-7-1</td> <td>fine-stranded</td> <td></td> <td>V</td> <td>A</td> </tr> <tr> <td>UL ratings</td> <td>field/factory wiring</td> <td>70 – 150 mm<sup>2</sup></td> <td>1000 V</td> <td>335</td> </tr> <tr> <td>CSA ratings</td> <td></td> <td>No. 0 AWG – 300 MCM</td> <td>600 V</td> <td>275</td> </tr> <tr> <td>Width</td> <td>wire strip length</td> <td>42 mm</td> <td></td> <td>27 mm</td> </tr> <tr> <td>Approvals</td> <td colspan="4"> </td> </tr> </tbody> </table>	Description	Color	Type	Part No.	Std. Pack	<b>Configuration F</b>	gray	RFK 1/150 F S35	56.397.0055.0	10	<b>Configuration K</b>	gray	RFK 1/150 K S35	56.397.0155.0	10	<b>Configuration FK</b>	gray	RFK 1/150 FK S35	56.397.0255.0	10	<b>Configuration FMK</b>	gray	RFK 1/150 FMK S35	56.397.1255.0	10	DIN VDE 0611 sect. 1/EN 60 947-7-1	fine-stranded		V	A	UL ratings	field/factory wiring	70 – 150 mm <sup>2</sup>	1000 V	335	CSA ratings		No. 0 AWG – 300 MCM	600 V	275	Width	wire strip length	42 mm		27 mm	Approvals									
Description	Color	Type	Part No.	Std. Pack																																																				
<b>Configuration F</b>	gray	RFK 1/150 F S35	56.397.0055.0	10																																																				
<b>Configuration K</b>	gray	RFK 1/150 K S35	56.397.0155.0	10																																																				
<b>Configuration FK</b>	gray	RFK 1/150 FK S35	56.397.0255.0	10																																																				
<b>Configuration FMK</b>	gray	RFK 1/150 FMK S35	56.397.1255.0	10																																																				
DIN VDE 0611 sect. 1/EN 60 947-7-1	fine-stranded		V	A																																																				
UL ratings	field/factory wiring	70 – 150 mm <sup>2</sup>	1000 V	335																																																				
CSA ratings		No. 0 AWG – 300 MCM	600 V	275																																																				
Width	wire strip length	42 mm		27 mm																																																				
Approvals																																																								
<p><b>RFK 1/185... S35</b></p>	<table border="1"> <thead> <tr> <th>Description</th> <th>Color</th> <th>Type</th> <th>Part No.</th> <th>Std. Pack</th> </tr> </thead> <tbody> <tr> <td><b>Configuration F</b></td> <td>gray</td> <td>RFK 1/185 F S35</td> <td>56.398.0055.0</td> <td>10</td> </tr> <tr> <td><b>Configuration FM</b></td> <td>gray</td> <td>RFK 1/185 FM S35</td> <td>56.398.1055.0</td> <td>10</td> </tr> </tbody> </table> <table border="1"> <tbody> <tr> <td>DIN VDE 0611 sect. 1/EN 60 947-7-1</td> <td></td> <td></td> <td>V</td> <td>A</td> </tr> <tr> <td>UL ratings</td> <td>field/factory wiring</td> <td></td> <td>1000 V/8 kV/3</td> <td>353</td> </tr> <tr> <td>CSA ratings</td> <td></td> <td>No. 0 AWG – 400 kcmil</td> <td>600 V</td> <td>375</td> </tr> <tr> <td>Width</td> <td>wire strip length</td> <td>42 mm</td> <td></td> <td>27 mm</td> </tr> <tr> <td>Approvals</td> <td colspan="4"> </td> </tr> </tbody> </table>	Description	Color	Type	Part No.	Std. Pack	<b>Configuration F</b>	gray	RFK 1/185 F S35	56.398.0055.0	10	<b>Configuration FM</b>	gray	RFK 1/185 FM S35	56.398.1055.0	10	DIN VDE 0611 sect. 1/EN 60 947-7-1			V	A	UL ratings	field/factory wiring		1000 V/8 kV/3	353	CSA ratings		No. 0 AWG – 400 kcmil	600 V	375	Width	wire strip length	42 mm		27 mm	Approvals																			
Description	Color	Type	Part No.	Std. Pack																																																				
<b>Configuration F</b>	gray	RFK 1/185 F S35	56.398.0055.0	10																																																				
<b>Configuration FM</b>	gray	RFK 1/185 FM S35	56.398.1055.0	10																																																				
DIN VDE 0611 sect. 1/EN 60 947-7-1			V	A																																																				
UL ratings	field/factory wiring		1000 V/8 kV/3	353																																																				
CSA ratings		No. 0 AWG – 400 kcmil	600 V	375																																																				
Width	wire strip length	42 mm		27 mm																																																				
Approvals																																																								
<p><b>RFK 1/240... S35</b></p>	<table border="1"> <thead> <tr> <th>Description</th> <th>Color</th> <th>Type</th> <th>Part No.</th> <th>Std. Pack</th> </tr> </thead> <tbody> <tr> <td><b>Configuration F</b></td> <td>gray</td> <td>RFK 1/240 F S35*)</td> <td>56.399.0055.0</td> <td>10</td> </tr> <tr> <td><b>Configuration K</b></td> <td>gray</td> <td>RFK 1/240 K S35</td> <td>56.399.0155.0</td> <td>10</td> </tr> <tr> <td><b>Configuration FK</b></td> <td>gray</td> <td>RFK 1/240 FK S35*)</td> <td>56.399.0255.0</td> <td>10</td> </tr> <tr> <td><b>Configuration FM</b></td> <td>gray</td> <td>RFK 1/240 FM S35*)</td> <td>56.399.1055.0</td> <td>10</td> </tr> <tr> <td><b>Configuration FMK</b></td> <td>gray</td> <td>RFK 1/240 FMK S35*)</td> <td>56.399.1255.0</td> <td>10</td> </tr> </tbody> </table> <table border="1"> <tbody> <tr> <td>DIN VDE 0611 sect. 1/EN 60 947-7-1</td> <td>fine-stranded</td> <td>stranded</td> <td>V</td> <td>A</td> </tr> <tr> <td>UL ratings</td> <td>field/factory wiring</td> <td>70 – 240 mm<sup>2</sup></td> <td>1000 V/8 kV/3</td> <td>415</td> </tr> <tr> <td>CSA ratings</td> <td></td> <td>No. 0 AWG – 500 kcmil</td> <td>600 V</td> <td>375</td> </tr> <tr> <td>Width</td> <td>wire strip length</td> <td>No. 3/0 AWG – 500 kcmil</td> <td>600 V</td> <td>425</td> </tr> <tr> <td>Approvals</td> <td colspan="4"> </td> </tr> </tbody> </table>	Description	Color	Type	Part No.	Std. Pack	<b>Configuration F</b>	gray	RFK 1/240 F S35*)	56.399.0055.0	10	<b>Configuration K</b>	gray	RFK 1/240 K S35	56.399.0155.0	10	<b>Configuration FK</b>	gray	RFK 1/240 FK S35*)	56.399.0255.0	10	<b>Configuration FM</b>	gray	RFK 1/240 FM S35*)	56.399.1055.0	10	<b>Configuration FMK</b>	gray	RFK 1/240 FMK S35*)	56.399.1255.0	10	DIN VDE 0611 sect. 1/EN 60 947-7-1	fine-stranded	stranded	V	A	UL ratings	field/factory wiring	70 – 240 mm <sup>2</sup>	1000 V/8 kV/3	415	CSA ratings		No. 0 AWG – 500 kcmil	600 V	375	Width	wire strip length	No. 3/0 AWG – 500 kcmil	600 V	425	Approvals				
Description	Color	Type	Part No.	Std. Pack																																																				
<b>Configuration F</b>	gray	RFK 1/240 F S35*)	56.399.0055.0	10																																																				
<b>Configuration K</b>	gray	RFK 1/240 K S35	56.399.0155.0	10																																																				
<b>Configuration FK</b>	gray	RFK 1/240 FK S35*)	56.399.0255.0	10																																																				
<b>Configuration FM</b>	gray	RFK 1/240 FM S35*)	56.399.1055.0	10																																																				
<b>Configuration FMK</b>	gray	RFK 1/240 FMK S35*)	56.399.1255.0	10																																																				
DIN VDE 0611 sect. 1/EN 60 947-7-1	fine-stranded	stranded	V	A																																																				
UL ratings	field/factory wiring	70 – 240 mm <sup>2</sup>	1000 V/8 kV/3	415																																																				
CSA ratings		No. 0 AWG – 500 kcmil	600 V	375																																																				
Width	wire strip length	No. 3/0 AWG – 500 kcmil	600 V	425																																																				
Approvals																																																								

\*) Only use cable protectors according to DIN 46234.

# High-current terminal blocks with screw connection

mm <sup>2</sup>	Type	a x b	M I	M II	H	L	F	E
185	F, FM	6 x 26	M 12	–	–	200	92	46
	F, FM	8 x 26	M 12	–	–	200	92	46
240	FK, FMK	8 x 26	M 12	M 12	100.5	200	102	46
	K	8 x 26	–	M 12	100.5	200	112	56

## Configurations

**F**

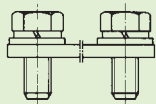

**K**

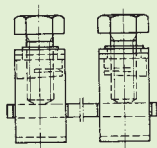

**FK**

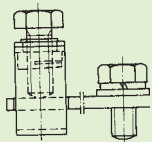

**FM**

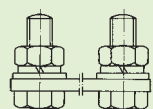

**FMK**

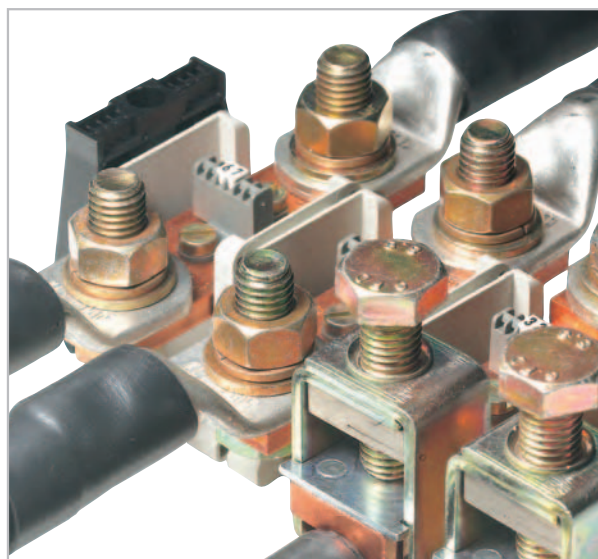
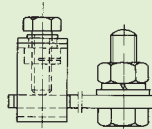



# RST 25i3





## Solar applications for systems up to 32A for single-phase power 3 pole

### Application example

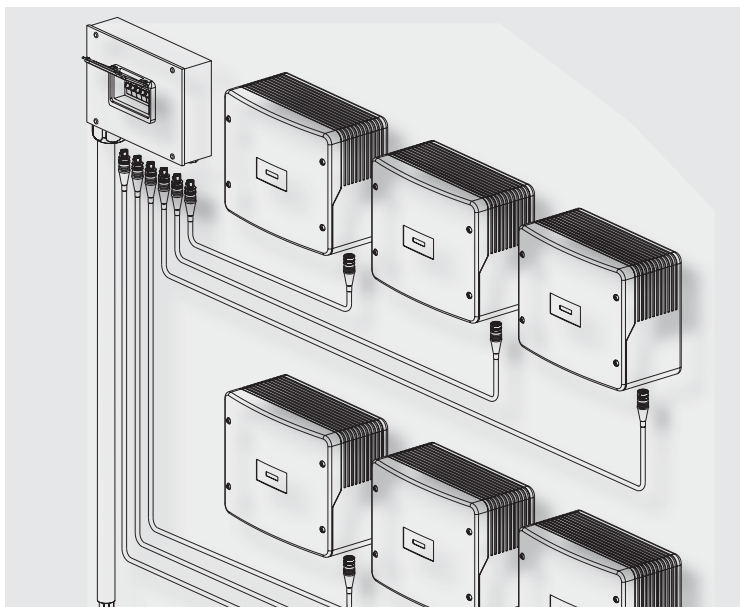

### General

The system is specially adapted to the requirements of solar technology. The connectors can be loaded with a maximum of 32 A on two contacts (L, N) and are used for single-phase power with ENS.

Special distribution boxes are used to bundle the electrical power of up to 6 inverters and thus complete the system.

These connectors have their own mechanical coding.

This means that only associated pairs of male and female can be connected with the correct polarity. This ensures a clear separation from the connectors of the other product series.

### Features:

- Fast mounting through easy handling
- UV-resistant
- Rated current up to 32 A (with 6.0 mm<sup>2</sup>)
- Cross-sections up to 6 mm<sup>2</sup>
- Degree of protection IP65, IP66, IP67, IP68 (3 m, 2 h)

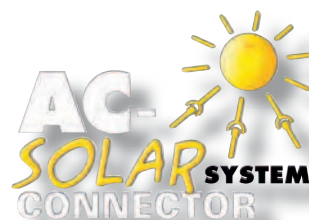

### Coding

For daily updates visit the website at <a href="http://eshop.wieland-electric.com">http://eshop.wieland-electric.com</a> . Assembly instructions and other technical information can be found in the Technical Data or in e-KAT.				<b>Application</b>	Single-phase power
				<b>Mechanical coding, for example</b>	250 V, 32 A L, N, ⊕ 
<b>Name</b>	<b>Description</b>	<b>Connection style</b>	<b>Strain relief housing</b>	<b>Connection points per pole</b>	concrete gray
<b>Connectors</b>	1 x cable entry	Screw	yes	1	✓
<b>Distribution units</b>	Distribution box RST RAN Solar Distribution box RST Solar				✓ ✓
<b>Device connectors</b>	M25 device connector, standard				✓
<b>Cable assemblies</b>	Connection cable Male – Free end	pre-assembled	pre-assembled	pre-assembled	✓
	Connection cable Female – Free end	pre-assembled	pre-assembled	pre-assembled	✓
	Extension cable Male – Female	pre-assembled	pre-assembled	pre-assembled	✓



## Connectors, 25 A (32 A with 6.0 mm<sup>2</sup>)

### Female connector

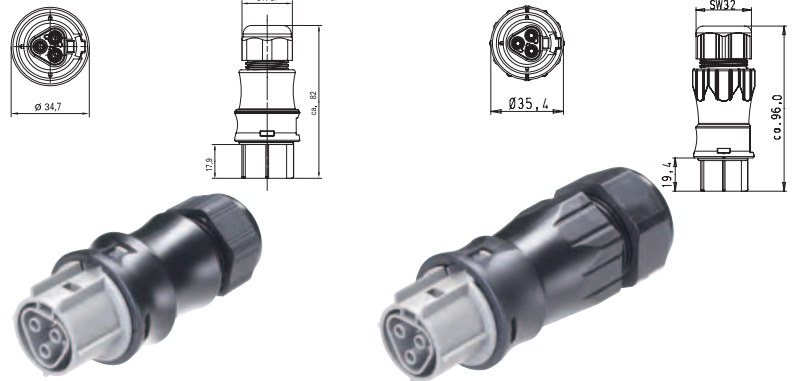

Application	Coding	Color	Part No.	Part No.									
Single-phase power 250V		concrete gray/black	<b>Screw technology for cable Ø 10 –14 mm</b>										
			<table border="1"> <tr> <td>Wire</td> <td>mm<sup>2</sup></td> <td></td> </tr> <tr> <td>solid</td> <td></td> <td></td> </tr> <tr> <td>fine-stranded</td> <td>up to 6.0<sup>2)</sup></td> <td>without ferrules</td> </tr> </table>		Wire	mm <sup>2</sup>		solid			fine-stranded	up to 6.0 <sup>2)</sup>	without ferrules
Wire	mm <sup>2</sup>												
solid													
fine-stranded	up to 6.0 <sup>2)</sup>	without ferrules											
			96.031.4154.3	96.031.4554.3									
			<b>Screw technology for cable Ø 13 –18 mm</b>										
			<table border="1"> <tr> <td>Wire</td> <td>mm<sup>2</sup></td> <td></td> </tr> <tr> <td>solid</td> <td></td> <td></td> </tr> <tr> <td>fine-stranded</td> <td>up to 6.0<sup>2)</sup></td> <td>without ferrules</td> </tr> </table>		Wire	mm <sup>2</sup>		solid			fine-stranded	up to 6.0 <sup>2)</sup>	without ferrules
Wire	mm <sup>2</sup>												
solid													
fine-stranded	up to 6.0 <sup>2)</sup>	without ferrules											

### Male connector

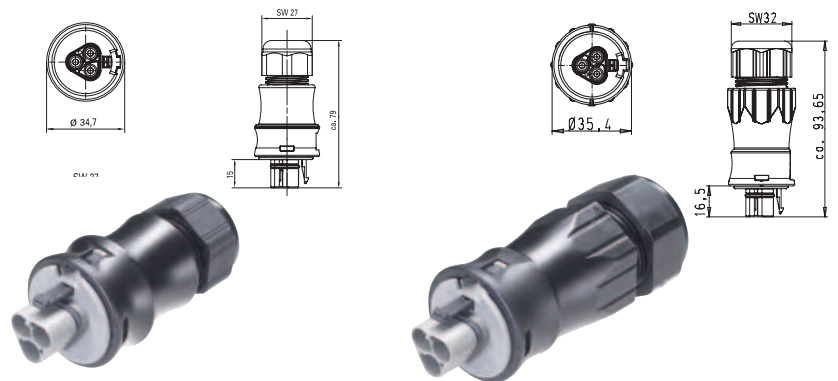

Application	Coding	Color	Part No.	Part No.												
Single-phase power 250V		concrete gray/black	<b>Screw technology for cable Ø 10 –14 mm</b>													
			<table border="1"> <tr> <td>Wire</td> <td>mm<sup>2</sup></td> <td></td> </tr> <tr> <td>solid</td> <td></td> <td></td> </tr> <tr> <td>fine-stranded</td> <td>up to 6.0<sup>2)</sup></td> <td>without ferrules</td> </tr> <tr> <td>Locking device</td> <td>yes</td> <td></td> </tr> </table>		Wire	mm <sup>2</sup>		solid			fine-stranded	up to 6.0 <sup>2)</sup>	without ferrules	Locking device	yes	
Wire	mm <sup>2</sup>															
solid																
fine-stranded	up to 6.0 <sup>2)</sup>	without ferrules														
Locking device	yes															
			96.032.4154.3	96.032.4554.3												
			<b>Screw technology for cable Ø 13 –18 mm</b>													
			<table border="1"> <tr> <td>Wire</td> <td>mm<sup>2</sup></td> <td></td> </tr> <tr> <td>solid</td> <td></td> <td></td> </tr> <tr> <td>fine-stranded</td> <td>up to 6.0<sup>2)</sup></td> <td>without ferrules</td> </tr> <tr> <td>Locking device</td> <td>yes</td> <td></td> </tr> </table>		Wire	mm <sup>2</sup>		solid			fine-stranded	up to 6.0 <sup>2)</sup>	without ferrules	Locking device	yes	
Wire	mm <sup>2</sup>															
solid																
fine-stranded	up to 6.0 <sup>2)</sup>	without ferrules														
Locking device	yes															

<sup>1)</sup> Larger cross-sections available on request  
<sup>2)</sup> With 6.0 mm<sup>2</sup> wires, the pull and bending forces at the connector must be taken into consideration and compensated by suitable measures if required

## M 25 device connector, 25 A (32 A with 6.0 mm<sup>2</sup>)

### Female connector With sealing option

For spacer rings for unlocking the device connector, see Accessories.

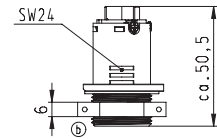
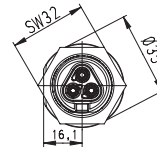

Application Coding Color

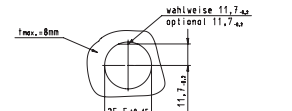

Single-phase power 250 V



concrete gray/black

Part No.

Screw technology		
Wire	mm <sup>2</sup>	
solid	up to 6.0	without ferrules
fine-stranded		
Locking device	yes	

96.031.5054.3

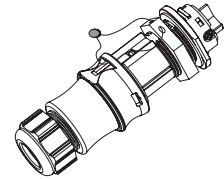

### Male connector With sealing option

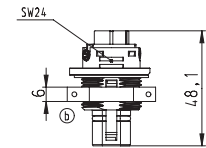
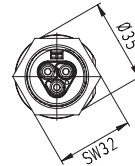

Application Coding Color

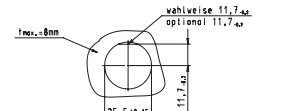

Single-phase power 250 V



concrete gray/black

Part No.

Screw technology		
Wire	mm <sup>2</sup>	
solid	up to 6.0	without ferrules
fine-stranded		
Locking device	yes	

96.032.5054.3

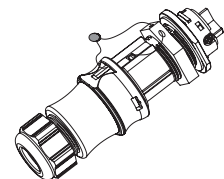

## Distribution units

### RST-Distribution box RST RAN Solar



Name	Material	Part No.
RST RAN Solar	Sheet metal/ powder-coated	99.512.0000.7

Detailed information about the distribution units available in section "Distribution units".

Inputs	6 x RST25i3 / concrete gray coding
Cable gland	1 x M40, 2 x M20
Connector clamps	3 x 35 mm <sup>2</sup>
Circuit breakers	6 x B25
Dimensions in mm (L x W x H)	350 x 300 x 100 mm

### Distribution box RST Solar



Distribution box RST Solar	Plastic	99.502.0000.7
----------------------------	---------	---------------

Detailed information about the distribution units available in section "Distribution units".

Inputs	3 x RST25i3 / concrete gray coding
Cable gland	1 x M32, 2 x M20
Connector clamps	5 x 10 mm <sup>2</sup>
Dimensions in mm (L x W x H)	180 x 180 x 90 mm

## Cable assemblies, 4.0 mm<sup>2</sup>, 25 A

### H05VV-F 3G4.0<sup>1)</sup>



N = BU  
L = BN  
⊕ = GN/YE

Observe the installation instructions in the Technical Data that follow the product pages.

The cable colors have been adapted to the new European standard HD 208 S2. The assignment corresponds to international recommendations.

Cable: black  
Coding: concrete gray/black

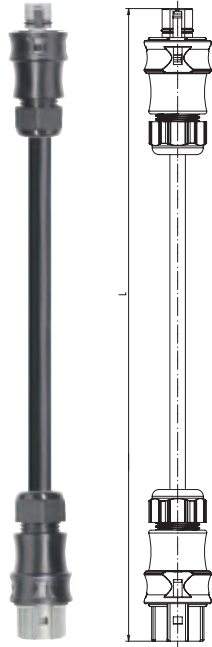

Female – Male	
Extension cable	
Locking device	yes

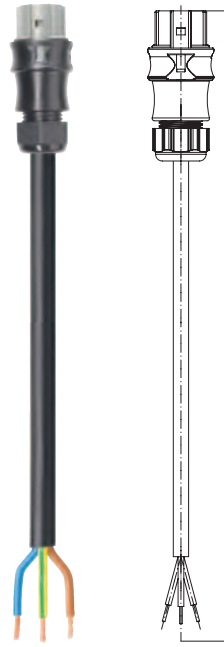

Female – Free end	
Connection cable	
Wire ends	ultrason. welded
Sheath strip length	35 mm
Insul. strip length	9 mm
Cable diameter	10.5 – 13.1 mm
H05VV-F <sup>2)</sup>	

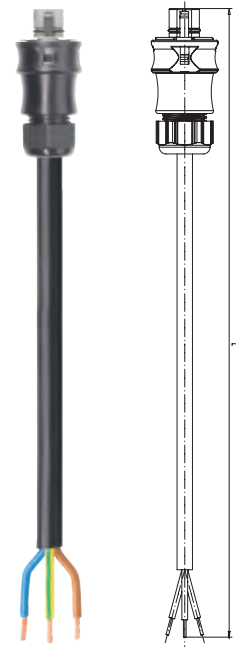

Male – Free end	
Connection cable	
Wire ends	ultrason. welded
Sheath strip length	35 mm
Insul. strip length	9 mm
Locking device	yes
Cable diameter	10.5 – 13.1 mm
H05VV-F <sup>2)</sup>	

Application	Length <sup>2)</sup> m	Part No.	Part No.	Part No.
Single-phase power 250V	1.0	96.834.1000.3	96.834.1003.3	96.834.1004.3
	1.5	96.834.1500.3	96.834.1503.3	96.834.1504.3
	2.0	96.834.2000.3	96.834.2003.3	96.834.2004.3
	2.5	96.834.2500.3	96.834.2503.3	96.834.2504.3
	3.0	96.834.3000.3	96.834.3003.3	96.834.3004.3
L, N, ⊕	3.5	96.834.3500.3	96.834.3503.3	96.834.3504.3
	4.0	96.834.4000.3	96.834.4003.3	96.834.4004.3





# Cable assemblies, 4.0 mm<sup>2</sup>, 25 A

## H07RN-F 3G4.0<sup>1)</sup>



N = BU  
L = BN  
⊕ = GN/YE

Observe the installation instructions in the Technical Data that follow the product pages.

The cable colors have been adapted to the new European standard HD 208 S2. The assignment corresponds to international recommendations.

Cable: black  
Coding: concrete gray/black

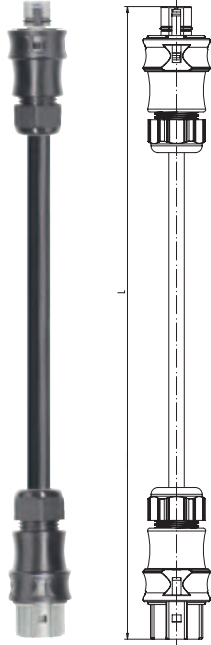

Female - Male	
Extension cable	
Locking device	yes

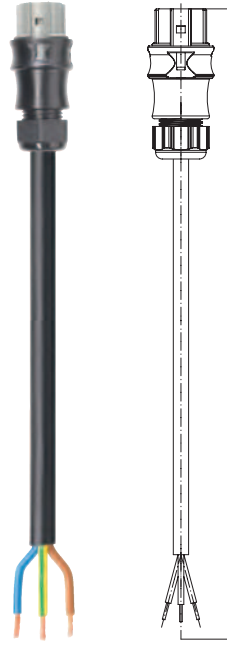

Female - Free end	
Connection cable	
Wire ends	ultrason. welded
Sheath strip length	35 mm
Insul. strip length	9 mm
Cable diameter	10.5 - 13.1 mm
H07RN-F <sup>2)</sup>	

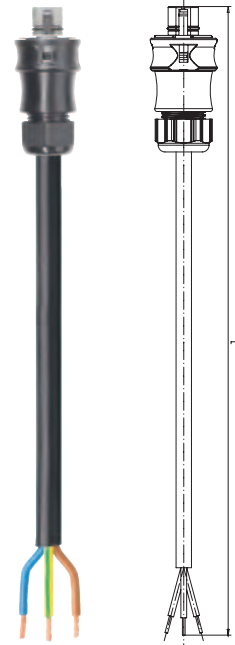

Male - Free end	
Connection cable	
Wire ends	ultrason. welded
Sheath strip length	35 mm
Insul. strip length	9 mm
Locking device	yes
Cable diameter	10.5 - 13.1 mm
H07RN-F <sup>3)</sup>	

Application	Length <sup>2)</sup> m	Part No.	Application	Length <sup>2)</sup> m	Part No.	Application	Length <sup>2)</sup> m	Part No.
Single-phase power 250 V	1.0	96.834.1030.3	Single-phase power 250 V	1.0	96.834.1033.3	Single-phase power 250 V	1.0	96.834.1034.3
	1.5	96.834.1530.3		1.5	96.834.1533.3		1.5	96.834.1534.3
	2.0	96.834.2030.3		2.0	96.834.2033.3		2.0	96.834.2034.3
	2.5	96.834.2530.3		2.5	96.834.2533.3		2.5	96.834.2534.3
	3.0	96.834.3030.3		3.0	96.834.3033.3		3.0	96.834.3034.3
	3.5	96.834.3530.3		3.5	96.834.3533.3		3.5	96.834.3534.3
L, N, ⊕	4.0	96.834.4030.3	L, N, ⊕	4.0	96.834.4033.3	L, N, ⊕	4.0	96.834.4034.3

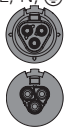

<sup>1)</sup> Other cables available on request  
<sup>2)</sup> Other lengths available on request  
<sup>3)</sup> According to VDE 0281/T5 and VDE 0288/T4

# RST 25i5





## Solar applications up to 25 A for single-phase supply with three-phase power monitoring or three-phase supply

### Application example

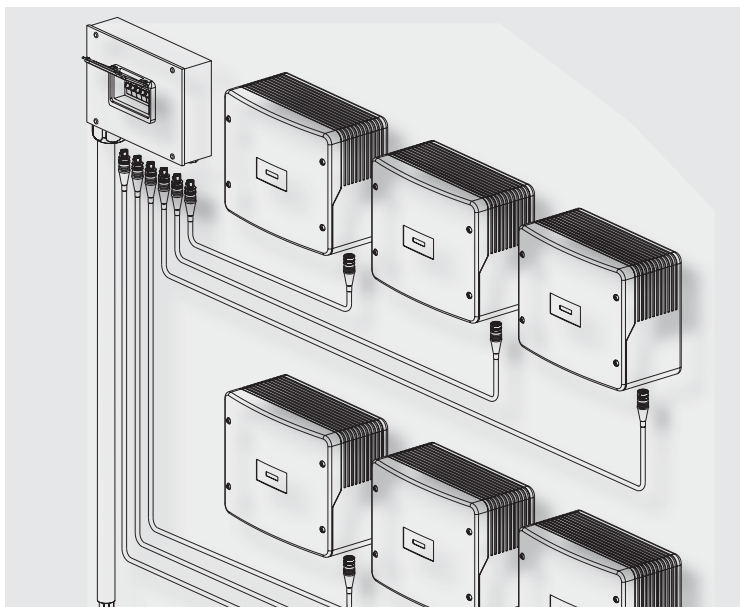

### General

The system has been specially adapted to the requirements of solar technology. The connectors can be loaded with 25A and are used for single-phase supply with power monitoring or three-phase supply.

Special distribution boxes are used to bundle the electrical power of up to 6 inverters and thus complete the system.

These connectors have their own mechanical coding.

This means that only associated pairs of male and female can be connected with the correct polarity. This ensures a clear separation from the connectors of the other product series.

### Features:

- Fast mounting through easy handling
- UV-resistant
- Rated current up to 25 A
- Cross-sections up to 6 mm<sup>2</sup>
- Degree of protection IP65 ... IP68 (on request)

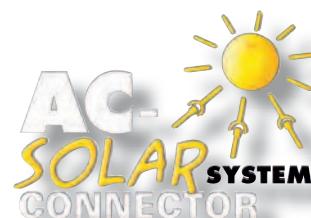

### Coding

For daily updates visit the website at <a href="http://eshop.wieland-electric.com">http://eshop.wieland-electric.com</a> . Assembly instructions and other technical information can be found in the Technical Data or in e-KAT.				<b>Application</b>	3-phase power
				<b>Mechanical coding, for example</b>	250/400V, 25 A L, N, ⊕, 1, 2 
<b>Name</b>	<b>Description</b>	<b>Connection style</b>	<b>Strain relief housing</b>	<b>Connection points per pole</b>	concrete gray
<b>Connectors</b>	1 x cable entry	Screw technology	yes	1	✓
<b>Distribution units</b>	Distribution box RST RAN Solar Distribution box RST Solar				✓ ✓
<b>Device connectors</b>	M25 device connector, standard				✓
<b>Cable assemblies</b>	Connection cable Male – Free end	pre-assembled	pre-assembled	pre-assembled	✓
	Connection cable Female – Free end	pre-assembled	pre-assembled	pre-assembled	✓
	Extension cable Male – Female	pre-assembled	pre-assembled	pre-assembled	✓



## Connectors, 25 A

### Female connector

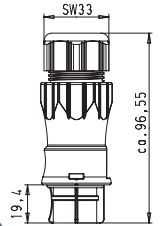
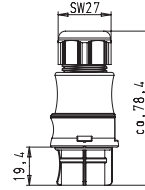

Application Coding Color

Part No.

Part No.

#### Screw technology for cable Ø 10 –14 mm

Wire	mm <sup>2</sup>	
solid		
fine-stranded	up to 4.0	without ferrules

#### Screw technology for cable Ø 13 –18 mm

Wire	mm <sup>2</sup>	
solid	up to 4.0	
fine-stranded	up to 6.0	without ferrules

3-phase power  
250/400 V,  
25 A



concrete  
gray/  
black

96.051.4154.3 4.0 mm<sup>2</sup>

96.051.4554.3 4.0 mm<sup>2</sup>

99.575.0000.7 6.0 mm<sup>2</sup>

### Male connector

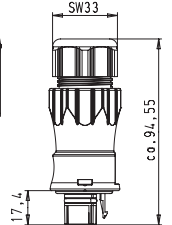
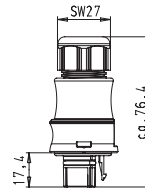

Application Coding Color

Part No.

Part No.

#### Screw technology for cable Ø 10 –14 mm

Wire	mm <sup>2</sup>	
solid		
fine-stranded	up to 4.0	without ferrules

#### Screw technology for cable Ø 13 –18 mm

Wire	mm <sup>2</sup>	
solid	up to 4.0	
fine-stranded	up to 6.0	without ferrules

3-phase power  
250/400 V,  
25 A



concrete  
gray/  
black

96.052.4154.3 4.0 mm<sup>2</sup>

96.052.4554.3 4.0 mm<sup>2</sup>

99.576.0000.7 6.0 mm<sup>2</sup>

## M 25 device connector, 25 A

### Female connector

#### With sealing option

For spacer rings for unlocking the device connector, see Accessories.

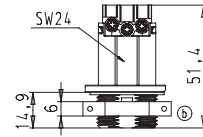
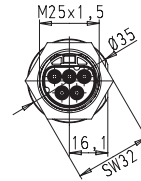
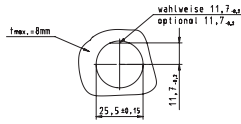

Application Coding Color Part No.

3-phase power 250/400 V, 25 A	 L, N, ⊕, 1, 2	concrete gray/ black
-------------------------------------	-------------------	----------------------------

Screw technology		
Wire	mm <sup>2</sup>	
solid	up to 4.0	without ferrules
fine-stranded	up to 6.0	without ferrules
96.051.5054.3	4.0 mm <sup>2</sup>	
99.577.0000.7	6.0 mm <sup>2</sup>	

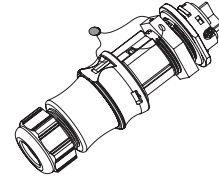

### Male connector

#### With sealing option

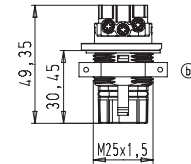
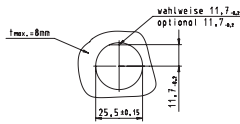

Application Coding Color Part No.

3-phase power 250/400 V, 25 A	 L, N, ⊕, 1, 2	concrete gray/ black
-------------------------------------	-------------------	----------------------------

Screw technology		
Wire	mm <sup>2</sup>	
solid	up to 4.0	without ferrules
fine-stranded	up to 6.0	without ferrules
96.052.5054.3	4.0 mm <sup>2</sup>	
99.578.0000.7	6.0 mm <sup>2</sup>	

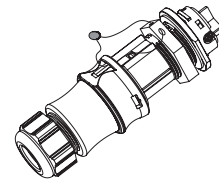

## Distribution units

### RST Distribution box RST RAN Solar



Name	Material	Part No.
RST RAN Solar	Sheet metal/ powder-coated	99.527.0000.7

Detailed information about the distribution units available in section "Distribution units".

Inputs	6 x RST25i5 / Concrete gray coding
Cable gland	1 x M40, 2 x M20
Connector clamps	5 x 35 mm <sup>2</sup>
Circuit breakers	6 x B25
Dimensions in mm (L x W x H)	350 x 300 x 100 mm

### Distribution box RST Solar



Name	Material	Part No.
Distribution box RST Solar	Plastic	99.528.0000.7

Detailed information about the distribution units available in section "Distribution units".

Inputs	3 RST25i5 / Concrete gray coding
Cable gland	1 x M32, 2 x M20
Connector clamps	5 x 10 mm <sup>2</sup>
Dimensions in mm (L x W x H)	180 x 180 x 90 mm

## Cable assemblies, 4.0 mm<sup>2</sup>, 25 A

### H05VV-F 5G4.0<sup>1)</sup>



N = BU  
L = GY  
⊕ = GN/YE  
1 = BN  
2 = BK

Observe the installation instructions in the Technical Data that follow the product pages.

The cable colors have been adapted to the new European standard HD 208 S2.

The assignment corresponds to international recommendations.

Cable: black  
Coding: concrete gray/black

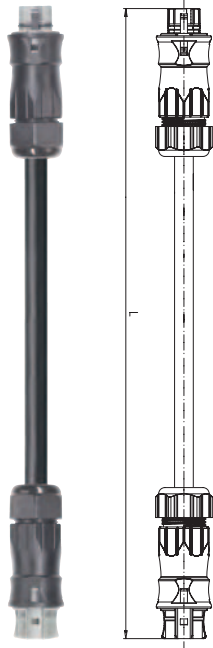

Female – Male	
Extension cable	
Locking device	yes

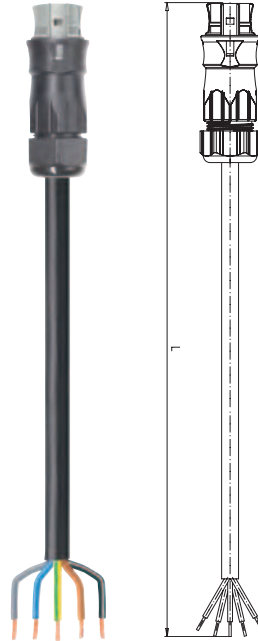

Female – Free end	
Connection cable	
Wire ends	ultrason. welded
Sheath strip length	35 mm
Insul. strip length	9 mm
Cable diameter	13.0 – 16.1 mm
H05VV-F <sup>2)</sup>	

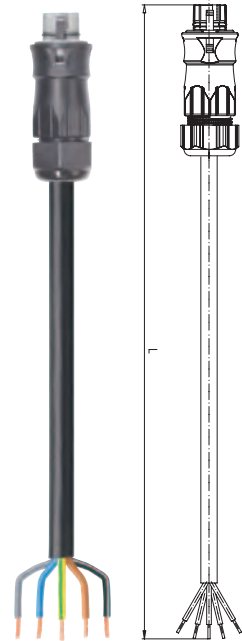

Male – Free end	
Connection cable	
Wire ends	ultrason. welded
Sheath strip length	35 mm
Insul. strip length	9 mm
Locking device	yes
Cable diameter	13.0 – 16.1 mm
H05VV-F <sup>2)</sup>	

Application	Length <sup>2)</sup> m	Part No.	Part No.	Part No.
3-phase power	1.0	96.854.1000.3	96.854.1003.3	96.854.1004.3
	1.5	96.854.1500.3	96.854.1503.3	96.854.1504.3
250/400 V, 25 A	2.0	96.854.2000.3	96.854.2003.3	96.854.2004.3
	2.5	96.854.2500.3	96.854.2503.3	96.854.2504.3
	3.0	96.854.3000.3	96.854.3003.3	96.854.3004.3
L, N, ⊕, 1, 2	3.5	96.854.3500.3	96.854.3503.3	96.854.3504.3
	4.0	96.854.4000.3	96.854.4003.3	96.854.4004.3

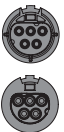



## Cable assemblies, 4.0 mm<sup>2</sup>, 25 A

### H07RN-F 5G4.0<sup>1)</sup>



N = BU  
L = GY  
⊕ = GN/YE  
1 = BN  
2 = BK

Observe the installation instructions in the Technical Data that follow the product pages.

The cable colors have been adapted to the new European standard HD 208 S2. The assignment corresponds to international recommendations.

Cable: black  
Coding: concrete gray/black

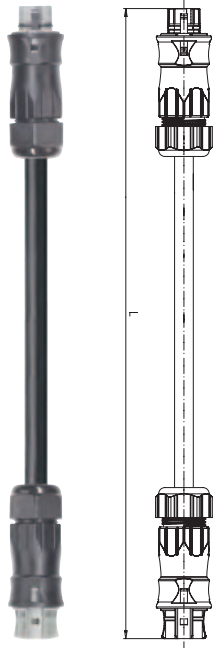

#### Female - Male

Extension cable

Locking device yes

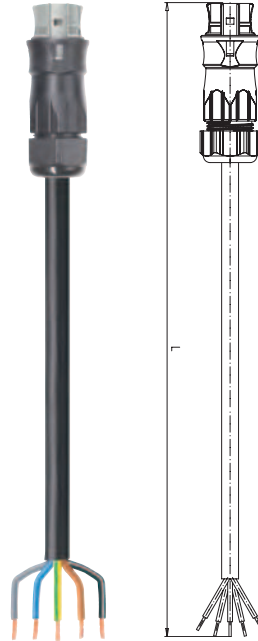

#### Female - Free end

Connection cable

Wire ends ultrason. welded

Sheath strip length 35 mm

Insul. strip length 9 mm

Cable diameter H07RN-F<sup>2)</sup> 15.6 – 19.9 mm

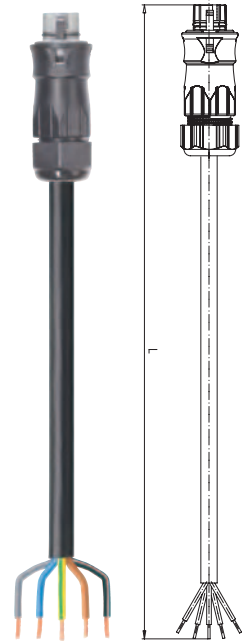

#### Male - Free end

Connection cable

Wire ends ultrason. welded

Sheath strip length 35 mm

Insul. strip length 9 mm

Locking device yes

Cable diameter H07RN-F<sup>3)</sup> 15.6 – 19.9 mm

Application	Length <sup>2)</sup> m	Part No.
3-phase power	1.0	96.854.1030.3
	1.5	96.854.1530.3
250/400 V, 25 A	2.0	96.854.2030.3
	2.5	96.854.2530.3
	3.0	96.854.3030.3
L, N, ⊕, 1, 2	3.5	96.854.3530.3
	4.0	96.854.4030.3



Application	Length <sup>2)</sup> m	Part No.
3-phase power	1.0	96.854.1033.3
	1.5	96.854.1533.3
250/400 V, 25 A	2.0	96.854.2033.3
	2.5	96.854.2533.3
	3.0	96.854.3033.3
L, N, ⊕, 1, 2	3.5	96.854.3533.3
	4.0	96.854.4033.3

Application	Length <sup>2)</sup> m	Part No.
3-phase power	1.0	96.854.1034.3
	1.5	96.854.1534.3
250/400 V, 25 A	2.0	96.854.2034.3
	2.5	96.854.2534.3
	3.0	96.854.3034.3
L, N, ⊕, 1, 2	3.5	96.854.3534.3
	4.0	96.854.4034.3

<sup>1)</sup> Other cables available on request

<sup>2)</sup> Other lengths available on request

<sup>3)</sup> According to VDE 0281/T5 and VDE 0288/T4

# Technical data

## RST 25i3 and RST 25i5

	RST 25i3	RST 25i5
Rated voltage	250 V	250 / 400 V
Rated current	32 A (with 6mm <sup>2</sup> )	25 A
Number of poles	3 pole	5 pole
Operating ambient temperature at peak load	55 °C	55 °C

**Continuous operating temperature::**

-40° C to +100° C  
Cable H05VV max 70 °C, H07RN-F max. 60 °C

**Material:**

Contact parts: brass, surface-plated  
Housing parts: thermoplastic material PA 66, halogen-free, V2  
Sealing material: NBR

**Regulations:**

IEC 61535 (VDE 0606); DIN EN 61984 (VDE 0627); VDE 0110  
IEC 60999; UL 2238; CSA: C22.2 No.182.2-M1987;  
LR Type Approval System

**Pollution degree:**

3 (when plugged in)

**Mating cycles:**

according to IEC 61535  
100 times without load and 50 times at rated load (cos φ = 0.6)

**Approvals:**

VDE; LR; GL; DNV; ATEX; CSA\*\*; UL\* (observe the conditions of acceptability)

\* without pre-assembled cables with shrinkage tube technology and connectors with spring clamp technology

\*\* without pre-assembled cables with shrinkage tube technology

**Degree of protection:**

IP 65, IP 66, IP 67 and IP 68 (3 m; 2 hours)  
Please observe the Installation Instructions (see Installation Instructions)

**IK code:**

IK7 (2 Joule)

**Glow-wire test**

850° C, 30 s:

For connectors, distribution units, cable assemblies and device connectors

**Coding:**

Mechanical coding symbolized by color code. Gray and black with the same mechanical coding. Other codings are optional.

**Note:**

Protection against shock generally guaranteed even when disconnected.  
Ground conductor leading. Connection to the live cable must be with a female connector according to the regulations. It is therefore not possible to have a ring circuit arrangement.

Only pluggable in the correct pole configuration; 1 pole cannot be connected.  
Contacts protected against strain on the cable. All components can be interlocked.

**A locking device is required for IEC 61535 approval. DIN VDE 0606 T200 conformity does not automatically exclude the danger of confusion with third-party installation plug connector systems! Installation plug connector systems are no substitute for national plug/ outlet systems for domestic use. IEC 60364-5-52 must be observed – see note under „Electrical installations with increased degree of protection“.**

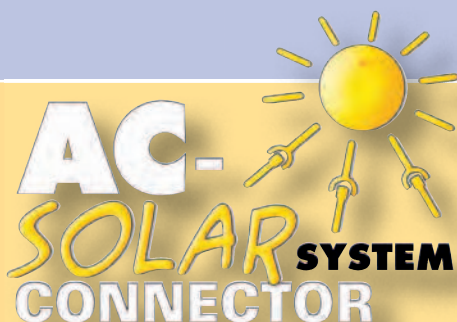

**gesis**<sup>®</sup> AC-SOLAR in use.

**gesis**<sup>®</sup> AC-SOLAR is extremely flexible in its applications. In addition to its use in photovoltaic systems **gesis**<sup>®</sup> AC-SOLAR SOLAR is also suitable for the following areas: Emergency power supply through batteries in buildings or systems; inversion of on-board voltage (cars, trucks, railroad, recreational vehicles, boats); metal working; power generation (fuel cell, wind power plants).

# Inverter connection examples

## Selecting the right connector

Individual application up to 5 kWp

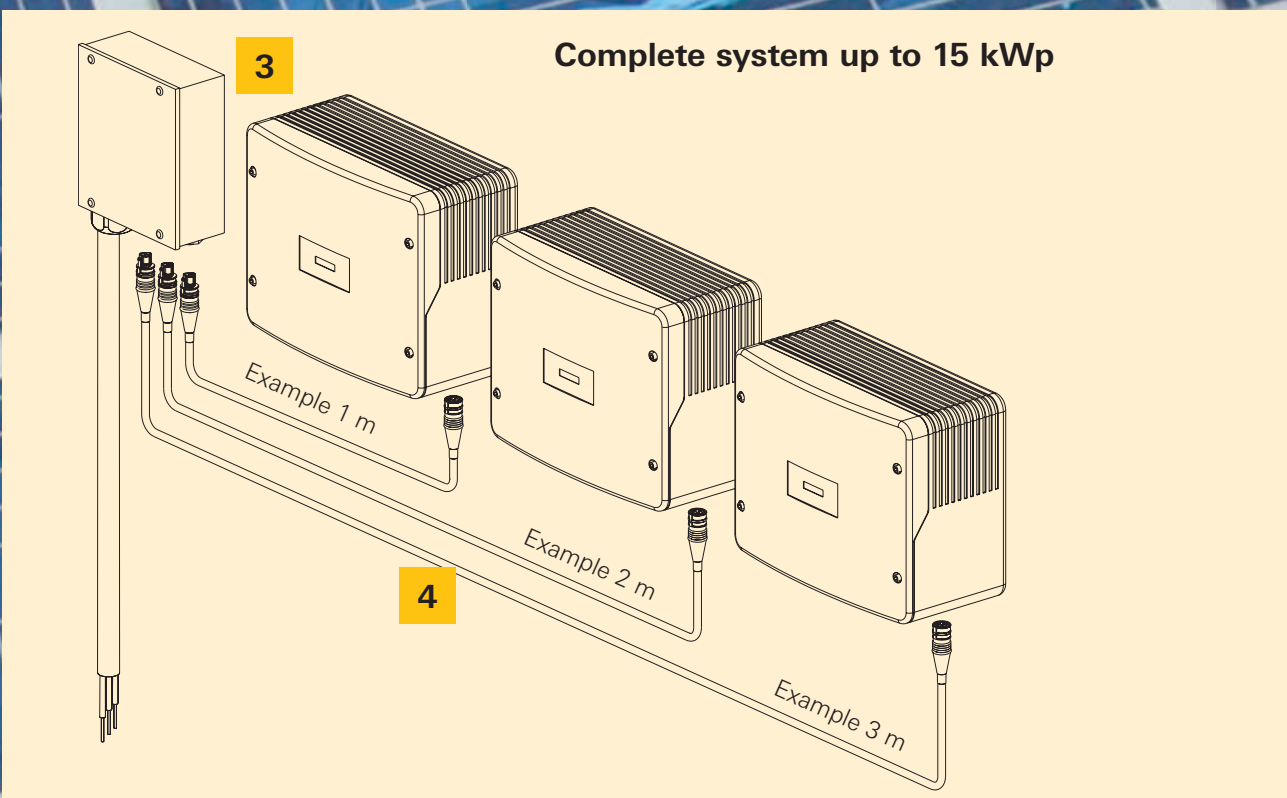
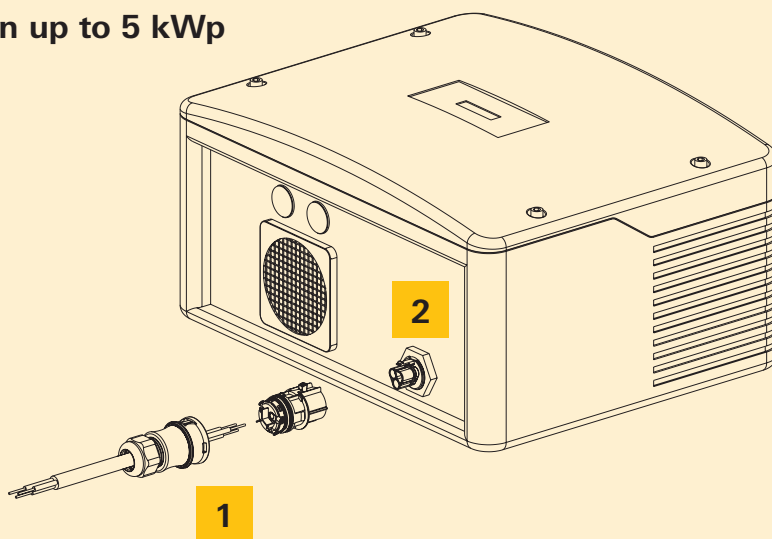

- 1** Connector (female) for field assembly
- 2** Device connection (male) for installation in the inverter housing<sup>1)</sup>  
<sup>1)</sup> Numerous well-known manufacturers offer their devices with pre-installed RST connections.
- 3** Combiner box  
RST SOLAR
- 4** Cable assemblies for the connection from the inverter to the combiner box (in all lengths as required)



# Installation of the field-assembled connectors

Connect the wires ....

... and disconnect them

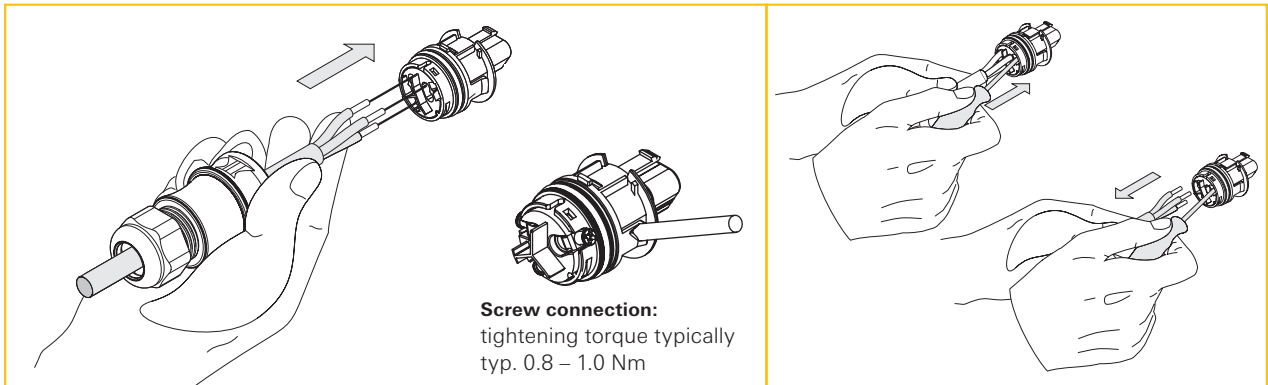

Close the connector ...

... and open it

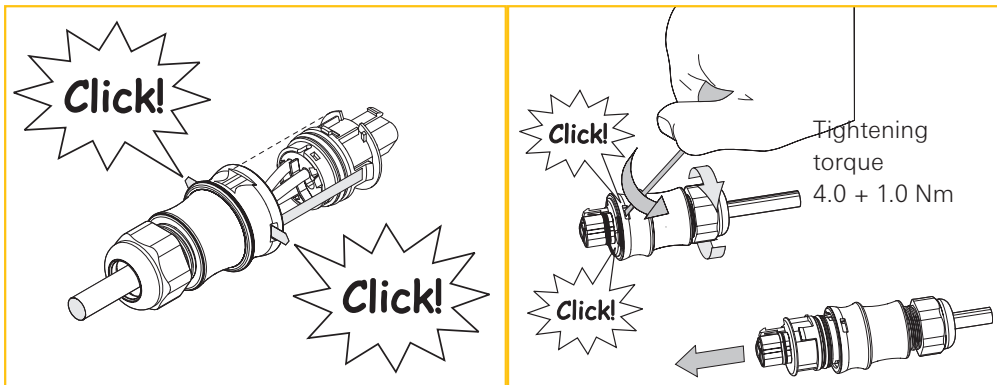

Lock the housing ...

... and unlock it

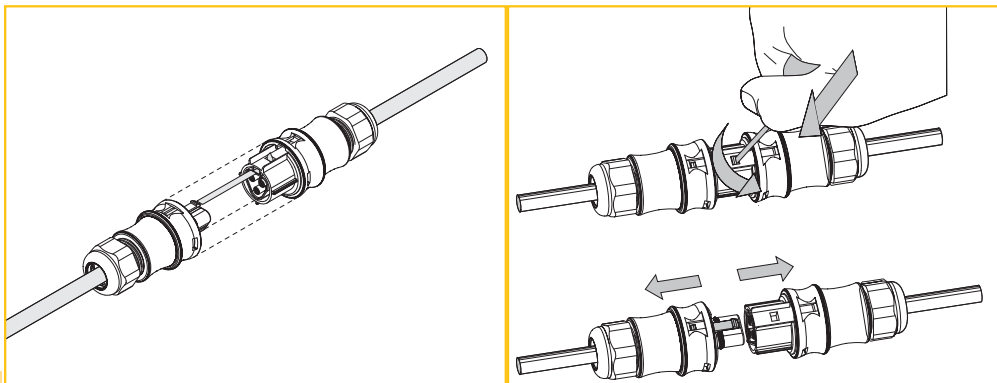

How to insert the (optional) manual disconnect into the connector  
(only possible for the female connector)

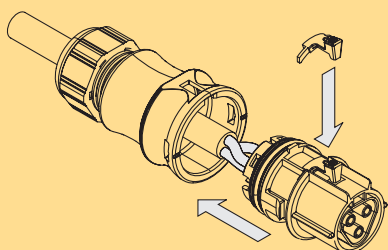

The manual disconnect\* can be used as an alternative and enables disconnecting without a tool.

\* Note:  
Connections with manual disconnect are not approved according to VDE 0606 (fixed installations, for example in buildings). The VDE 0627 regulation will still apply nevertheless. Also see the "Installation instructions"! The descriptions on this page merely serve as an overview. For assembly and installation, only the installation instructions supplied together with the products are binding

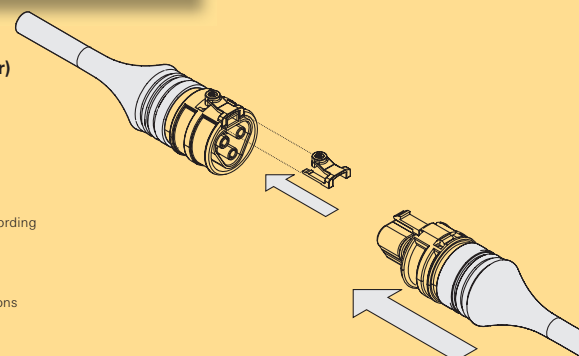

# Housing installation

Installation of a standard system, for M 20 feed-through

Dimensions in mm

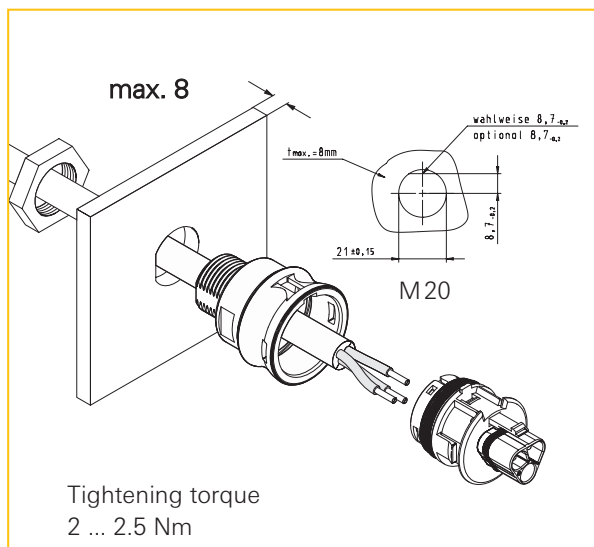

Installation of a standard system, for M 25 feed-through

Dimensions in mm

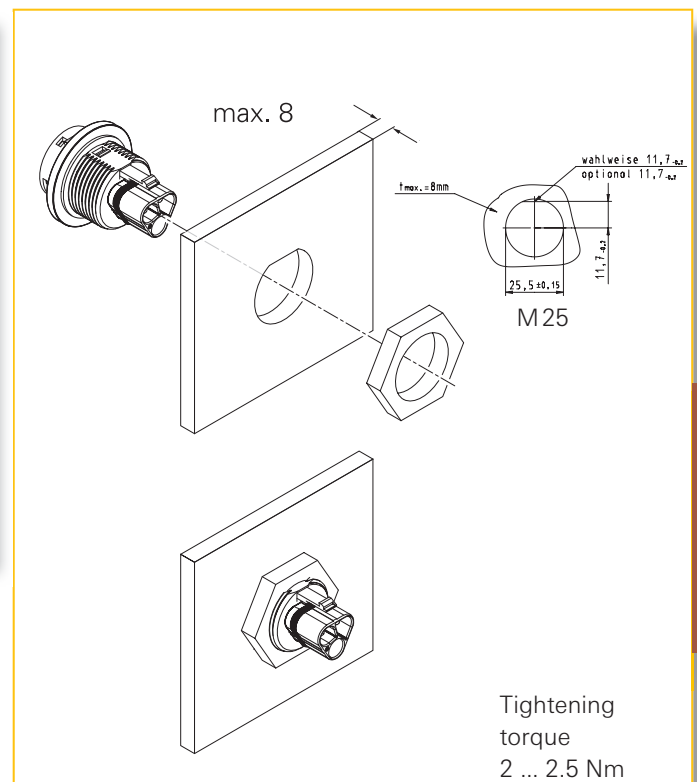

**Note:**

Effectiveness of the protection against twisting can only be guaranteed when the lower tolerance limit is ensured for the diameter of the hole.

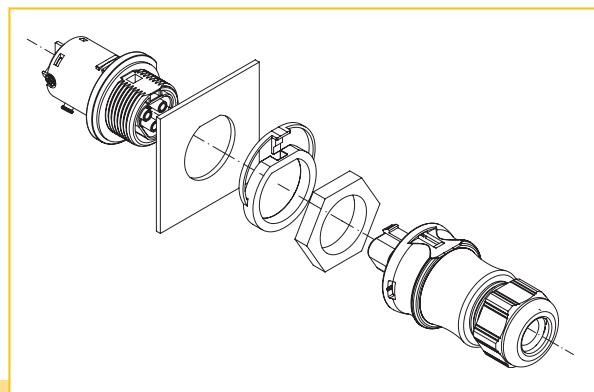

**Bending radius (for conductors)**

Note the minimum bending radius for conductors > 2.5 mm<sup>2</sup>. Pull forces on the contact points can be avoided by proceeding as follows:

- ① Bend the wire as required
- ② Cut the wire to length
- ③ Strip the cable and wires

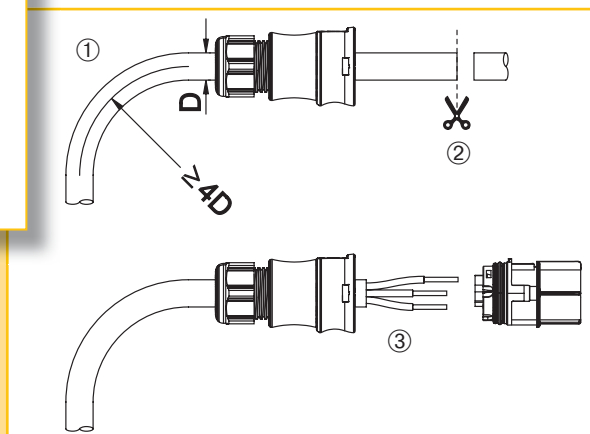



RST 50i5





## The new RST Power series up to 50A

### Application example

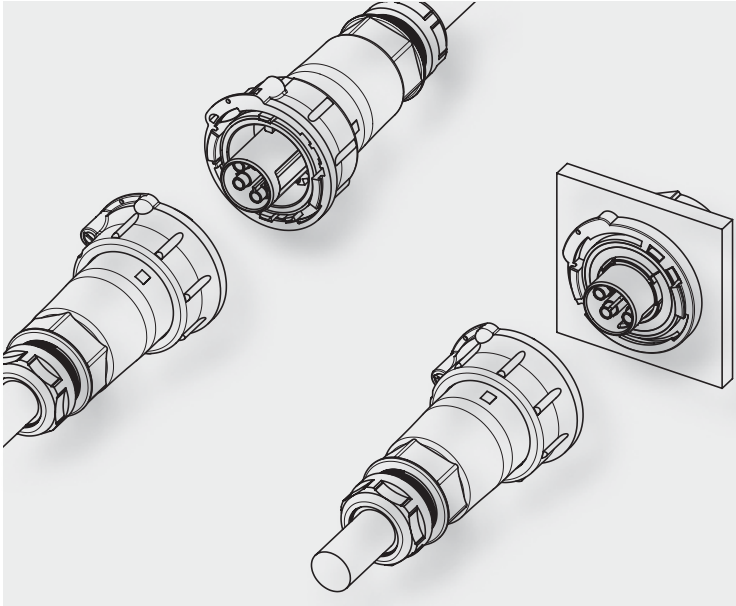

### General

The new RST Power series is particularly designed for device engineering. With a current-carrying capability of 50A combined with an extremely compact design, the connector fits almost everywhere.

### Coding

For daily updates visit the website at <a href="http://eshop.wieland-electric.com">http://eshop.wieland-electric.com</a> . Assembly instructions and other technical information can be found in the Technical Data or in e-KAT.				<b>Application</b>	Power max. 50 A
				<b>Mechanical coding for example</b>	250 / 400 V 1, 2, 3, N, ⊕ 
<b>Name</b>	<b>Description</b>	<b>Connection style</b>	<b>Strain relief housing</b>	<b>Connection points per pole</b>	black
<b>Connectors</b>	1 x wire entry	Screw Spring clamp	yes	1	✓
<b>Device connectors</b>	M32 connector, standard	Screw Spring clamp	yes	1	✓



## Connector with strain relief

### Female connector



Illustration  
M32 cable gland

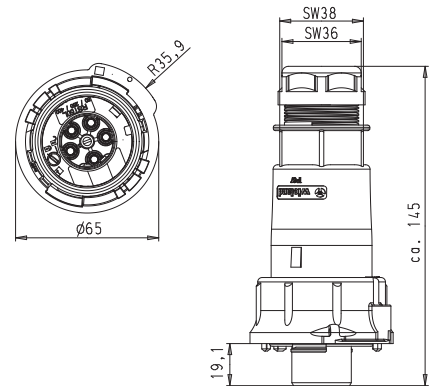

Application	Coding	Cable gland	Wire diameter	Color	Part No.	Part No.
Power max. 50		M32	15 – 25	black	97.051.4053.1	97.151.0053.1
		M40	20 – 32	black	97.051.4253.1	97.151.0253.1

with screw connection		with crimp connection	
Wires	mm <sup>2</sup>	Wires	mm <sup>2</sup>
solid	from 4.0 to 6.0*)	flexible wires	from 4.0 to 10.0
stranded		Approvals	VDE
flexible wires	from 4.0 to 16.0	Pole markings	⊕, 1, 2, 3, N
Approvals	VDE	Crimp contacts	order separately; see last page of section RST50i
Pole markings	⊕, 1, 2, 3, N		

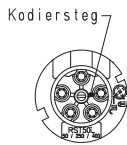

### Male connector



Illustration  
M40 cable gland

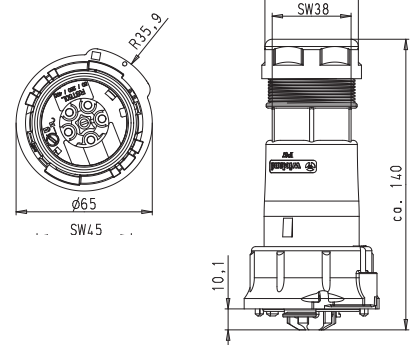

Application	Coding	Cable gland	Wire diameter	Color	Part No.	Part No.
Power max. 50		M32	15 – 25	black	97.052.4053.1	97.152.0053.1
		M40	20 – 32	black	97.052.4253.1	97.152.0253.1

with screw connection		with crimp connection	
Wires	mm <sup>2</sup>	Wires	mm <sup>2</sup>
solid	from 4.0 to 6.0*)	flexible wires	from 4.0 to 10.0
stranded		Approvals	VDE
flexible wires	from 4.0 to 16.0	Pole markings	⊕, 1, 2, 3, N
Approvals	VDE	Crimp contacts	order separately; see last page of section RST50i
Pole markings	⊕, 1, 2, 3, N		

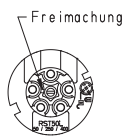

\*) Solid and stranded wires > 6.0mm<sup>2</sup> cannot be connected in the available space due to their rigidity.

## M32 device connector

### Female connector

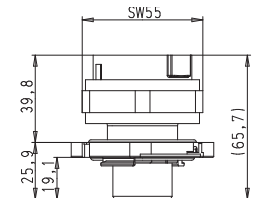
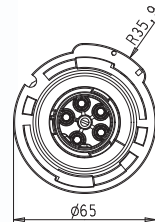

Application	Coding	Fixation with bolts	Color	Part No.	Part No.																				
Drilling template for device connectors fixed in position		fixed in position	black	<b>with screw connection</b>	<b>with crimp connection</b>																				
		not fixed in position	black	<table border="1"> <tr><td>Wires</td><td>mm<sup>2</sup></td></tr> <tr><td>solid</td><td>from 4.0 to 16.0</td></tr> <tr><td>stranded</td><td>from 4.0 to 16.0</td></tr> <tr><td>flexible wires</td><td>from 4.0 to 16.0</td></tr> <tr><td>Approvals</td><td>VDE</td></tr> <tr><td>Pole markings</td><td>⊕, 1, 2, 3, N</td></tr> </table>	Wires	mm <sup>2</sup>	solid	from 4.0 to 16.0	stranded	from 4.0 to 16.0	flexible wires	from 4.0 to 16.0	Approvals	VDE	Pole markings	⊕, 1, 2, 3, N	<table border="1"> <tr><td>Wires</td><td>mm<sup>2</sup></td></tr> <tr><td>flexible wires</td><td>from 4.0 to 10.0</td></tr> <tr><td>Approvals</td><td>VDE</td></tr> <tr><td>Pole markings</td><td>⊕, 1, 2, 3, N</td></tr> <tr><td>Crimp contacts</td><td>order separately; see last page of section RST50i</td></tr> </table>	Wires	mm <sup>2</sup>	flexible wires	from 4.0 to 10.0	Approvals	VDE	Pole markings	⊕, 1, 2, 3, N
Wires	mm <sup>2</sup>																								
solid	from 4.0 to 16.0																								
stranded	from 4.0 to 16.0																								
flexible wires	from 4.0 to 16.0																								
Approvals	VDE																								
Pole markings	⊕, 1, 2, 3, N																								
Wires	mm <sup>2</sup>																								
flexible wires	from 4.0 to 10.0																								
Approvals	VDE																								
Pole markings	⊕, 1, 2, 3, N																								
Crimp contacts	order separately; see last page of section RST50i																								
Power max. 50				97.051.5553.1 97.051.5053.1	97.151.1553.1 97.151.1053.1																				

### Male connector

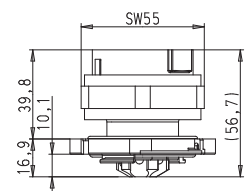
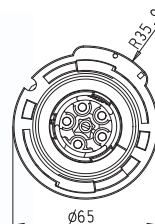

Application	Coding	Fixation with bolts	Color	Part No.	Part No.																				
Drilling template for device connectors fixed in position		fixed in position	black	<b>with screw connection</b>	<b>with crimp connection</b>																				
		not fixed in position	black	<table border="1"> <tr><td>Wires</td><td>mm<sup>2</sup></td></tr> <tr><td>solid</td><td>from 4.0 to 16.0</td></tr> <tr><td>stranded</td><td>from 4.0 to 16.0</td></tr> <tr><td>flexible wires</td><td>from 4.0 to 16.0</td></tr> <tr><td>Approvals</td><td>VDE</td></tr> <tr><td>Pole markings</td><td>⊕, 1, 2, 3, N</td></tr> </table>	Wires	mm <sup>2</sup>	solid	from 4.0 to 16.0	stranded	from 4.0 to 16.0	flexible wires	from 4.0 to 16.0	Approvals	VDE	Pole markings	⊕, 1, 2, 3, N	<table border="1"> <tr><td>Wires</td><td>mm<sup>2</sup></td></tr> <tr><td>flexible wires</td><td>from 4.0 to 10.0</td></tr> <tr><td>Approvals</td><td>VDE</td></tr> <tr><td>Pole markings</td><td>⊕, 1, 2, 3, N</td></tr> <tr><td>Crimp contacts</td><td>order separately; see last page of section RST50i</td></tr> </table>	Wires	mm <sup>2</sup>	flexible wires	from 4.0 to 10.0	Approvals	VDE	Pole markings	⊕, 1, 2, 3, N
Wires	mm <sup>2</sup>																								
solid	from 4.0 to 16.0																								
stranded	from 4.0 to 16.0																								
flexible wires	from 4.0 to 16.0																								
Approvals	VDE																								
Pole markings	⊕, 1, 2, 3, N																								
Wires	mm <sup>2</sup>																								
flexible wires	from 4.0 to 10.0																								
Approvals	VDE																								
Pole markings	⊕, 1, 2, 3, N																								
Crimp contacts	order separately; see last page of section RST50i																								
Power max. 50				97.052.5553.1 97.052.5053.1 <b>W</b>	97.152.1553.1 97.152.1053.1																				





## Convincing technology

### RST50i 4 pole/5 pole

Rated voltage:	250/400V	
Rated current:	50A	
Rated cross-section:	starre Wires von 4,0 mm <sup>2</sup> bis 6,0 mm <sup>2</sup> bei Steckverbindern (bis 16 mm <sup>2</sup> bei Geräteanschlüssen) fsolide Wires von 4,0 mm <sup>2</sup> bis 16,0 mm <sup>2</sup>	
Number of poles:	4 pole	5 pole
Pole designation:	1, 2, 3, ⊕	1, 2, 3, N, ⊕
Material:	Contact parts: brass, surface-plated Housing parts: thermoplastic material PA 66, halogen-free, V2 Sealing material NBR, TPE	
Degree of protection:	IP65, IP66, IP67	
Approvals:	VDE, UL, CSA being prepared	
Sheath strip length:	70 mm	
Insulation strip length:	Screw 10 mm (crimp 11 mm)	
Torques:	Cable gland S34: 12 Nm; S42: 14 Nm	

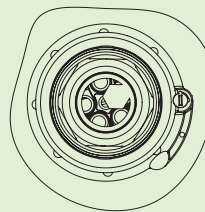
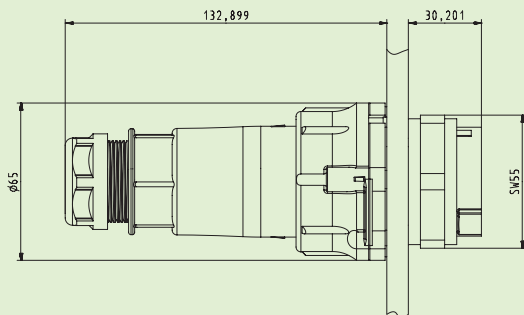

Hole pattern for M 32 device connectors, alternative M40 with adapter ring (fixed in position)

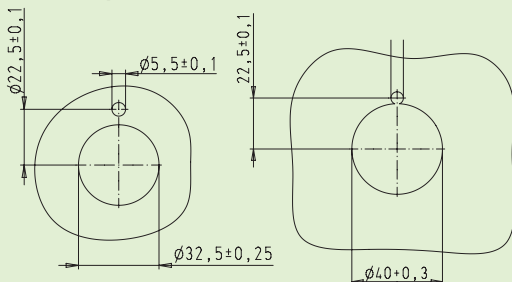

Alternative fixed in position (cams on the housing)

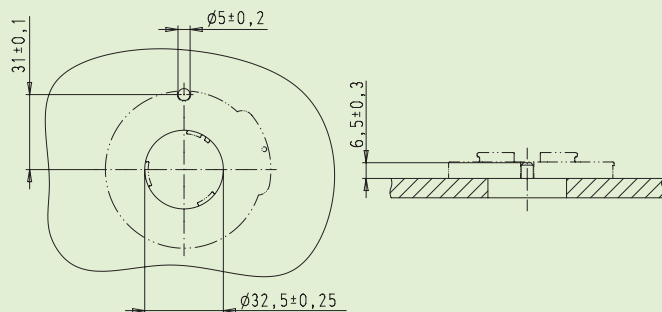

## Installation and pre-assembly



Insert the cable into the strain relief housing



Connect the wire terminate the wires via screw termination



Connect the contact insert into the housing



Fasten or loosen the contact insert



Snap the housing into the M 32 knock-out



M 40 adapter ring



Tighten the counter nuts inside



Install the contact insert





Fasten or loosen the contact insert

Bayonet lock with integrated protection against accidental disconnect

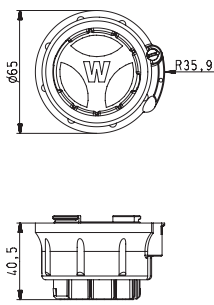

## Accessories

Cover	Name	Color	Part No.
		<b>Cover</b>	black
			
	For safe covering of unused male or female components		

Sample kit RST50i5	Name	Color	Part No.
		<b>Sample kit RST50i5</b>	black
	Complete kit including: – Connectors – Device connection – Cover piece – Knock-out (metal sheet)		

Crimping tool with system kit	Name	Color	Part No.
		<b>Crimping tool</b> (supplied in case)	
	<b>Crimping die D</b>		05.502.2300.0



## Accessories

<b>Crimp contacts</b> Female contacts	Name	ID (groove) mm <sup>2</sup>		Part No.
	<b>Crimp contact</b>	unmarked	4.0	02.126.0621.8
	<b>Crimp contact</b>	1	6.0	02.126.0721.8
	<b>Crimp contact</b>	unmarked	10.0	02.126.0821.8



<b>Crimp contacts</b> Male contacts	Name	ID (groove) mm <sup>2</sup>		Part No.
	<b>Crimp contact</b>	unmarked	4.0	05.545.2821.8
	<b>Crimp contact</b>	1	6.0	05.545.2921.8
	<b>Crimp contact</b>	unmarked	10.0	05.545.3021.8



<b>Adapter ring 40 mm</b>	Name	Color	Part No.
	<b>Adapter ring</b>	black	05.568.1853.0



For fixing the device connector inside  
40 mm knock-outs

## Description of the flammability classes in accordance with UL 94

### Flammability class HB

In the horizontal test for flammability the material is slowly flammable. For wall thicknesses under 3mm the incendiary speed must not exceed 3 inch/min; for wall thicknesses over 3mm it must not exceed 1.5inch/min. Materials which exceed these incendiary speed limit values will not be registered by UL.

### Flammability class V2

In the vertical test for flammability materials must self-extinguish within 25 seconds on average (individual values not more than 30 seconds). Material drippings can ignite cotton padding placed under the material. But afterglow must not exceed 60 seconds.

### Flammability class V1

In the vertical test for flammability materials must self-extinguish within 25 seconds on average (individual values not more than 30 seconds). But any drippings that may possibly occur must not ignite the cotton padding. Afterglow must be terminated within 30 seconds.

### Flammability class V0

In the vertical test for flammability materials must self-extinguish within less than 5 seconds on average (individual values not more than 10 seconds). Any drippings that may occur must not ignite the cotton padding and afterglow must be terminated within 30 seconds..

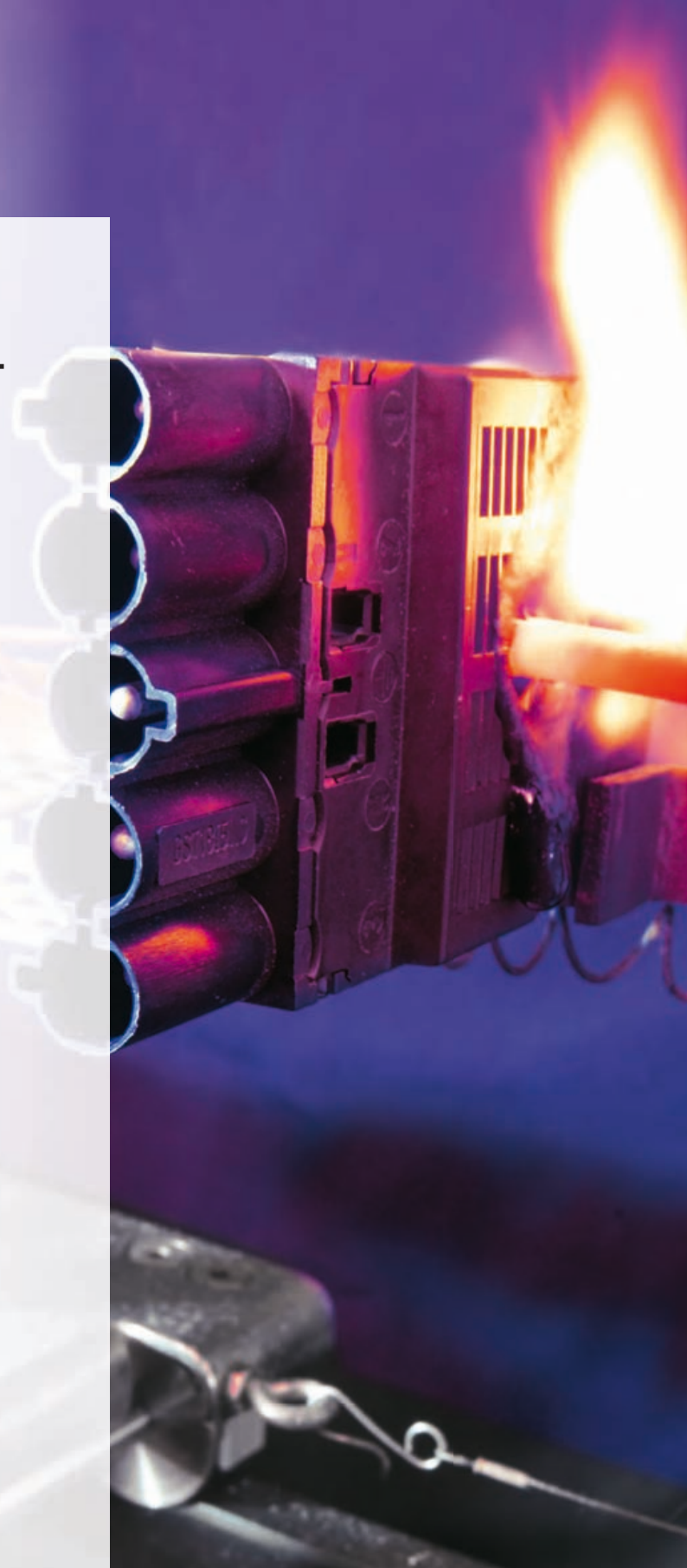

## Description of weathering resistance in accordance with UL 746 C

### Weathering resistance f1

Suitable for outdoor use with respect to exposure to Ultraviolet Light, Water Exposure and Immersion in accordance with UL 746 C.

### Weathering resistance f2

Subjected to one or more of the following tests: Ultraviolet Light, Water Exposure or Immersion in accordance with UL746 C, where the acceptability for outdoor use is to be determined by UL.

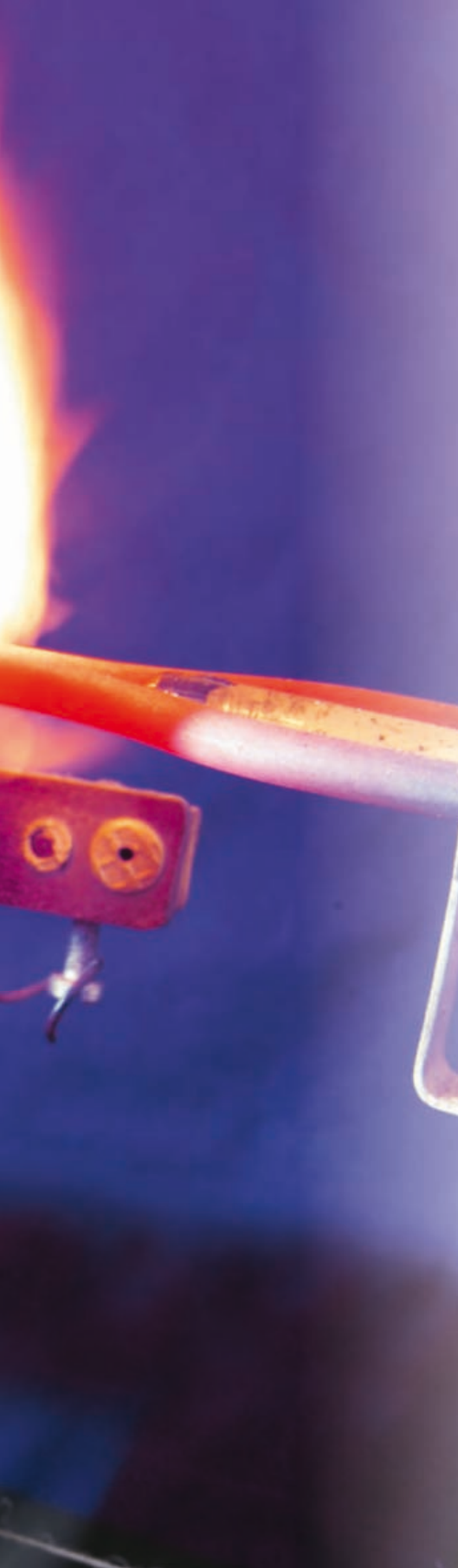

## Index – Part.No. – Group – Page

02.125.8202.8	■ PST40i1	11	07.313.2555.0	■ selos	40
02.125.8302.8	■ PST40i1	11	07.313.2555.0	■ selos	40
02.125.8402.8	■ PST40i1	11	07.313.2555.0	■ selos	40
02.126.0621.8	■ RST50i5	71	07.313.2555.0	■ selos	41
02.126.0721.8	■ RST50i5	71	07.313.2655.0	■ selos	39
02.126.0821.8	■ RST50i5	71	07.313.2755.0	■ selos	39
04.325.1056.0	■ selos	43	07.313.2755.0	■ selos	41
04.325.1156.0	■ selos	44	07.313.2855.0	■ selos	39
04.325.1256.0	■ selos	44	54.003.7553.0	■ selos	43
04.325.1356.0	■ selos	45	54.003.7553.6	■ selos	43
04.325.1456.0	■ selos	45	54.004.7553.0	■ selos	43
04.325.1656.0	■ selos	43	54.004.7553.6	■ selos	43
04.344.1455.8	■ selos	39	54.010.7553.0	■ selos	44
04.344.1655.8	■ selos	39	54.010.7553.6	■ selos	44
04.344.1855.8	■ selos	39	54.016.7553.0	■ selos	44
04.344.1855.8	■ selos	39	54.016.7553.6	■ selos	44
04.344.2255.8	■ selos	39	54.025.7553.0	■ selos	45
05.502.1600.0	■ PST40i1	14	54.025.7553.6	■ selos	45
05.502.2300.0	■ RST50i5	70	54.035.7553.0	■ selos	45
05.508.3121.0	■ selos	44	54.035.7553.6	■ selos	45
05.508.3221.0	■ selos	44	56.395.0055.0	■ selos	46
05.508.6521.0	■ selos	45	56.395.0155.0	■ selos	46
05.508.6521.0	■ selos	45	56.395.0255.0	■ selos	46
05.508.8821.0	■ selos	43	56.395.1055.0	■ selos	46
05.508.8921.0	■ selos	43	56.395.1255.0	■ selos	46
05.545.2202.8	■ PST40i1	11	56.397.0055.0	■ selos	46
05.545.2302.8	■ PST40i1	11	56.397.0155.0	■ selos	46
05.545.2402.8	■ PST40i1	11	56.397.0255.0	■ selos	46
05.545.2821.8	■ RST50i5	71	56.397.1255.0	■ selos	46
05.545.2921.8	■ RST50i5	71	56.398.0055.0	■ selos	46
05.545.3021.8	■ RST50i5	71	56.398.1055.0	■ selos	46
05.566.6380.0	■ PST40i1	14	56.399.0055.0	■ selos	46
05.566.6480.0	■ PST40i1	14	56.399.0155.0	■ selos	46
05.568.1853.0	■ RST50i5	71	56.399.0255.0	■ selos	46
05.568.2756.0	■ PST40i1	14	56.399.1055.0	■ selos	46
05.593.5953.0	■ selos	44	56.399.1255.0	■ selos	46
07.310.3153.0	■ selos	43	58.503.0055.0	■ selos	38
07.310.3153.0	■ selos	43	58.503.0055.6	■ selos	38
07.310.3253.0	■ selos	44	58.503.9055.0	■ selos	40
07.310.3353.0	■ selos	45	58.504.0055.0	■ selos	38
07.310.3353.0	■ selos	45	58.504.0055.6	■ selos	38
07.310.3453.0	■ selos	43	58.504.9055.0	■ selos	40
07.310.3453.0	■ selos	43	58.506.0055.0	■ selos	38
07.310.3553.0	■ selos	44	58.506.0055.6	■ selos	38
07.310.3653.0	■ selos	45	58.506.9055.0	■ selos	40
07.310.3653.0	■ selos	45	58.510.0055.0	■ selos	39
07.310.3953.0	■ selos	44	58.510.0055.6	■ selos	39
07.310.4053.0	■ selos	44	58.510.9055.0	■ selos	41
07.313.2555.0	■ selos	38	58.516.0055.0	■ selos	39
07.313.2555.0	■ selos	38	58.516.0055.6	■ selos	39
07.313.2555.0	■ selos	38	58.516.9055.0	■ selos	41
07.313.2555.0	■ selos	39	84.995.0055.0	■ wietap	29























































84.995.0120.0	■ <b>wietap</b>	28
84.995.0222.0	■ <b>wietap</b>	29
84.995.1001.0	■ <b>wietap</b>	26
84.995.1001.0	■ <b>wietap</b>	26
84.995.1001.0	■ <b>wietap</b>	27
84.995.1001.0	■ <b>wietap</b>	27
84.995.1100.0	■ <b>wietap</b>	27
84.995.1100.0	■ <b>wietap</b>	27
84.995.1305.0	■ <b>wietap</b>	26
84.995.1315.0	■ <b>wietap</b>	27
84.995.1405.0	■ <b>wietap</b>	26
84.995.2010.0	■ <b>wietap</b>	24
84.995.2010.0	■ <b>wietap</b>	24
84.995.2010.0	■ <b>wietap</b>	30
84.995.2010.0	■ <b>wietap</b>	30
84.995.2010.0	■ <b>wietap</b>	31
84.995.2010.0	■ <b>wietap</b>	31
84.995.2015.0	■ <b>wietap</b>	25
84.995.2015.0	■ <b>wietap</b>	25
84.995.2050.0	■ <b>wietap</b>	31
84.995.2050.0	■ <b>wietap</b>	31
84.995.2051.0	■ <b>wietap</b>	25
84.995.2051.0	■ <b>wietap</b>	25
84.995.2053.0	■ <b>wietap</b>	24
84.995.2053.0	■ <b>wietap</b>	24
84.995.2305.0	■ <b>wietap</b>	30
84.995.2315.0	■ <b>wietap</b>	31
84.995.2405.0	■ <b>wietap</b>	30
84.995.2515.0	■ <b>wietap</b>	25
84.995.2516.0	■ <b>wietap</b>	24
95.101.0800.0	■ <b>RST50i5</b>	70
95.101.1500.0	■ <b>PST40i1</b>	15
95.101.1600.0	■ <b>PST40i1</b>	15
96.031.4154.3	■ <b>RST25i3</b>	50
96.031.4554.3	■ <b>RST25i3</b>	50
96.031.5054.3	■ <b>RST25i3</b>	51
96.032.4154.3	■ <b>RST25i3</b>	50
96.032.4554.3	■ <b>RST25i3</b>	50
96.032.5054.3	■ <b>RST25i3</b>	51
96.051.4154.3	■ <b>RST25i5</b>	56
96.051.4554.3	■ <b>RST25i5</b>	56
96.051.5054.3	■ <b>RST25i5</b>	57
96.052.4154.3	■ <b>RST25i5</b>	56
96.052.4554.3	■ <b>RST25i5</b>	56
96.052.5054.3	■ <b>RST25i5</b>	57
96.111.0053.1	■ <b>PST40i1</b>	10
96.111.0153.1	■ <b>PST40i1</b>	10
96.111.0253.1	■ <b>PST40i1</b>	10
96.111.1053.1	■ <b>PST40i1</b>	10
96.111.1253.1	■ <b>PST40i1</b>	10
96.111.1253.1	■ <b>PST40i1</b>	10
96.112.0053.1	■ <b>PST40i1</b>	10









































96.112.0153.1	■ <b>PST40i1</b>	10
96.112.0253.1	■ <b>PST40i1</b>	10
96.112.1053.1	■ <b>PST40i1</b>	10
96.311.1209.1	■ <b>PST40i1</b>	9
96.311.1309.1	■ <b>PST40i1</b>	9
96.311.1409.1	■ <b>PST40i1</b>	9
96.311.1509.1	■ <b>PST40i1</b>	9
96.311.1609.1	■ <b>PST40i1</b>	9
96.311.1709.1	■ <b>PST40i1</b>	9
96.311.1809.1	■ <b>PST40i1</b>	9
96.311.1909.1	■ <b>PST40i1</b>	9
96.311.2009.1	■ <b>PST40i1</b>	9
96.311.2109.1	■ <b>PST40i1</b>	9
96.311.2209.1	■ <b>PST40i1</b>	9
96.311.2309.1	■ <b>PST40i1</b>	9
96.311.2409.1	■ <b>PST40i1</b>	9
96.312.1000.1	■ <b>PST40i1</b>	9
96.312.1209.1	■ <b>PST40i1</b>	9
96.312.1309.1	■ <b>PST40i1</b>	9
96.312.1409.1	■ <b>PST40i1</b>	9
96.312.1509.1	■ <b>PST40i1</b>	9
96.312.1609.1	■ <b>PST40i1</b>	9
96.312.1709.1	■ <b>PST40i1</b>	9
96.312.1809.1	■ <b>PST40i1</b>	9
96.312.1909.1	■ <b>PST40i1</b>	9
96.312.2000.1	■ <b>PST40i1</b>	9
96.312.2009.1	■ <b>PST40i1</b>	9
96.312.2109.1	■ <b>PST40i1</b>	9
96.312.2209.1	■ <b>PST40i1</b>	9
96.312.2309.1	■ <b>PST40i1</b>	9
96.312.2409.1	■ <b>PST40i1</b>	9
96.312.3000.1	■ <b>PST40i1</b>	9
96.312.4000.1	■ <b>PST40i1</b>	9
96.312.5000.1	■ <b>PST40i1</b>	9
96.312.6000.1	■ <b>PST40i1</b>	9
96.313.1000.1	■ <b>PST40i1</b>	9
96.313.1209.1	■ <b>PST40i1</b>	9
96.313.1309.1	■ <b>PST40i1</b>	9
96.313.1409.1	■ <b>PST40i1</b>	9
96.313.1509.1	■ <b>PST40i1</b>	9
96.313.1609.1	■ <b>PST40i1</b>	9
96.313.1709.1	■ <b>PST40i1</b>	9
96.313.1809.1	■ <b>PST40i1</b>	9
96.313.1909.1	■ <b>PST40i1</b>	9
96.313.2000.1	■ <b>PST40i1</b>	9
96.313.2009.1	■ <b>PST40i1</b>	9
96.313.2109.1	■ <b>PST40i1</b>	9
96.313.2209.1	■ <b>PST40i1</b>	9
96.313.2309.1	■ <b>PST40i1</b>	9
96.313.2409.1	■ <b>PST40i1</b>	9
96.313.3000.1	■ <b>PST40i1</b>	9
96.313.4000.1	■ <b>PST40i1</b>	9



## Index – Part.No. – Group – Page

96.313.5000.1	■ PST40i1	9	96.854.1004.3	■ RST25i5	58
96.313.6000.1	■ PST40i1	9	96.854.1030.3	■ RST25i5	59
96.314.1000.1	■ PST40i1	9	96.854.1033.3	■ RST25i5	59
96.314.2000.1	■ PST40i1	9	96.854.1034.3	■ RST25i5	59
96.314.3000.1	■ PST40i1	9	96.854.1500.3	■ RST25i5	58
96.314.4000.1	■ PST40i1	9	96.854.1503.3	■ RST25i5	58
96.314.5000.1	■ PST40i1	9	96.854.1504.3	■ RST25i5	58
96.314.6000.1	■ PST40i1	9	96.854.1530.3	■ RST25i5	59
96.834.1000.3	■ RST25i3	52	96.854.1533.3	■ RST25i5	59
96.834.1003.3	■ RST25i3	52	96.854.1534.3	■ RST25i5	59
96.834.1004.3	■ RST25i3	52	96.854.2000.3	■ RST25i5	58
96.834.1030.3	■ RST25i3	53	96.854.2003.3	■ RST25i5	58
96.834.1033.3	■ RST25i3	53	96.854.2004.3	■ RST25i5	58
96.834.1034.3	■ RST25i3	53	96.854.2030.3	■ RST25i5	59
96.834.1500.3	■ RST25i3	52	96.854.2033.3	■ RST25i5	59
96.834.1503.3	■ RST25i3	52	96.854.2034.3	■ RST25i5	59
96.834.1504.3	■ RST25i3	52	96.854.2500.3	■ RST25i5	58
96.834.1530.3	■ RST25i3	53	96.854.2503.3	■ RST25i5	58
96.834.1533.3	■ RST25i3	53	96.854.2504.3	■ RST25i5	58
96.834.1534.3	■ RST25i3	53	96.854.2530.3	■ RST25i5	59
96.834.2000.3	■ RST25i3	52	96.854.2533.3	■ RST25i5	59
96.834.2003.3	■ RST25i3	52	96.854.2534.3	■ RST25i5	59
96.834.2004.3	■ RST25i3	52	96.854.3000.3	■ RST25i5	58
96.834.2030.3	■ RST25i3	53	96.854.3003.3	■ RST25i5	58
96.834.2033.3	■ RST25i3	53	96.854.3004.3	■ RST25i5	58
96.834.2034.3	■ RST25i3	53	96.854.3030.3	■ RST25i5	59
96.834.2500.3	■ RST25i3	52	96.854.3033.3	■ RST25i5	59
96.834.2503.3	■ RST25i3	52	96.854.3034.3	■ RST25i5	59
96.834.2504.3	■ RST25i3	52	96.854.3500.3	■ RST25i5	58
96.834.2530.3	■ RST25i3	53	96.854.3503.3	■ RST25i5	58
96.834.2533.3	■ RST25i3	53	96.854.3504.3	■ RST25i5	58
96.834.2534.3	■ RST25i3	53	96.854.3530.3	■ RST25i5	59
96.834.3000.3	■ RST25i3	52	96.854.3533.3	■ RST25i5	59
96.834.3003.3	■ RST25i3	52	96.854.3534.3	■ RST25i5	59
96.834.3004.3	■ RST25i3	52	96.854.4000.3	■ RST25i5	58
96.834.3030.3	■ RST25i3	53	96.854.4003.3	■ RST25i5	58
96.834.3033.3	■ RST25i3	53	96.854.4004.3	■ RST25i5	58
96.834.3034.3	■ RST25i3	53	96.854.4030.3	■ RST25i5	59
96.834.3500.3	■ RST25i3	52	96.854.4033.3	■ RST25i5	59
96.834.3503.3	■ RST25i3	52	96.854.4034.3	■ RST25i5	59
96.834.3504.3	■ RST25i3	52	97.051.4053.1	■ RST50i5	66
96.834.3530.3	■ RST25i3	53	97.051.4253.1	■ RST50i5	66
96.834.3533.3	■ RST25i3	53	97.051.5053.1	■ RST50i5	67
96.834.3534.3	■ RST25i3	53	97.051.5553.1	■ RST50i5	67
96.834.4000.3	■ RST25i3	52	97.052.4053.1	■ RST50i5	66
96.834.4003.3	■ RST25i3	52	97.052.4253.1	■ RST50i5	66
96.834.4004.3	■ RST25i3	52	97.052.5053.1	■ RST50i5	67
96.834.4030.3	■ RST25i3	53	97.052.5553.1	■ RST50i5	67
96.834.4033.3	■ RST25i3	53	97.151.0053.1	■ RST50i5	66
96.834.4034.3	■ RST25i3	53	97.151.0253.1	■ RST50i5	66
96.854.1000.3	■ RST25i5	58	97.151.1053.1	■ RST50i5	67
96.854.1003.3	■ RST25i5	58	97.151.1553.1	■ RST50i5	67

97.152.0053.1		<b>RST50i5</b>	66
97.152.0253.1		<b>RST50i5</b>	66
97.152.1053.1		<b>RST50i5</b>	67
97.152.1553.1		<b>RST50i5</b>	67
99.424.0000.0		<b>PST40i1</b>	15
99.426.0000.0		<b>PST40i1</b>	15
99.502.0000.7		<b>RST25i3</b>	51
99.512.0000.7		<b>RST25i3</b>	51
99.527.0000.7		<b>RST25i5</b>	57
99.528.0000.7		<b>RST25i5</b>	57
99.570.0000.7		<b>PST40i1</b>	14
99.575.0000.7		<b>RST25i5</b>	56
99.576.0000.7		<b>RST25i5</b>	56
99.577.0000.7		<b>RST25i5</b>	57
99.578.0000.7		<b>RST25i5</b>	57
99.628.0000.0		<b>RST50i5</b>	70
99.630.0000.0		<b>PST40i1</b>	15
Y6.111.0053.1		<b>PST40i1</b>	10
Y6.111.0153.1		<b>PST40i1</b>	10
Y6.111.0253.1		<b>PST40i1</b>	10
Y6.111.1053.1		<b>PST40i1</b>	10
Y6.111.1253.1		<b>PST40i1</b>	10
Y6.112.0053.1		<b>PST40i1</b>	10
Y6.112.0153.1		<b>PST40i1</b>	10
Y6.112.0253.1		<b>PST40i1</b>	10
Y6.112.1053.1		<b>PST40i1</b>	10
Y6.112.1253.1		<b>PST40i1</b>	10
Z5.566.6380.0		<b>PST40i1</b>	14
Z5.566.6480.0		<b>PST40i1</b>	14
Z5.567.5653.0		<b>RST50i5</b>	70
Z7.211.0027.0		<b>selos</b>	43
Z7.211.0227.0		<b>selos</b>	43
Z7.211.0327.0		<b>selos</b>	43
Z7.211.0427.0		<b>selos</b>	43
Z7.211.0527.0		<b>selos</b>	43
Z7.211.0627.0		<b>selos</b>	43
Z7.212.0227.0		<b>selos</b>	44
Z7.212.0327.0		<b>selos</b>	44
Z7.212.0427.0		<b>selos</b>	44
Z7.212.0527.0		<b>selos</b>	44
Z7.212.0627.0		<b>selos</b>	44
Z7.213.0227.0		<b>selos</b>	45
Z7.213.0327.0		<b>selos</b>	45
Z7.213.0427.0		<b>selos</b>	45
Z7.213.0527.0		<b>selos</b>	45
Z7.213.0627.0		<b>selos</b>	45
Z7.214.0227.0		<b>selos</b>	44
Z7.214.0327.0		<b>selos</b>	44
Z7.214.0427.0		<b>selos</b>	44
Z7.214.0527.0		<b>selos</b>	44
Z7.214.0627.0		<b>selos</b>	44
Z7.215.0027.0		<b>selos</b>	43

Z7.215.0227.0		<b>selos</b>	43
Z7.215.0327.0		<b>selos</b>	43
Z7.215.0427.0		<b>selos</b>	43
Z7.215.0527.0		<b>selos</b>	43
Z7.215.0627.0		<b>selos</b>	43
Z7.216.0227.0		<b>selos</b>	45
Z7.216.0327.0		<b>selos</b>	45
Z7.216.0427.0		<b>selos</b>	45
Z7.216.0527.0		<b>selos</b>	45
Z7.216.0627.0		<b>selos</b>	45
Z7.261.1227.0		<b>selos</b>	38
Z7.261.1327.0		<b>selos</b>	38
Z7.261.1427.0		<b>selos</b>	38
Z7.261.1527.0		<b>selos</b>	38
Z7.261.2027.0		<b>selos</b>	38
Z7.269.2923.0		<b>selos</b>	43
Z7.269.3023.0		<b>selos</b>	44
Z7.269.3123.0		<b>selos</b>	44
Z7.269.3223.0		<b>selos</b>	45
Z7.269.3423.0		<b>selos</b>	45
Z7.269.3523.0		<b>selos</b>	43
Z7.280.6227.0		<b>selos</b>	38
Z7.280.6327.0		<b>selos</b>	38
Z7.280.6427.0		<b>selos</b>	38
Z7.280.6527.0		<b>selos</b>	38
Z7.280.7027.0		<b>selos</b>	38
Z7.280.8027.0		<b>selos</b>	38
Z7.282.5227.0		<b>selos</b>	38
Z7.282.5327.0		<b>selos</b>	38
Z7.282.5427.0		<b>selos</b>	38
Z7.282.5527.0		<b>selos</b>	38
Z7.282.6027.0		<b>selos</b>	38
Z7.283.8227.0		<b>selos</b>	39
Z7.284.4227.0		<b>selos</b>	39
ZD.000.0011.0		<b>wienet</b>	34
ZD.000.0011.1		<b>wienet</b>	34
ZD.000.0012.0		<b>wienet</b>	34
ZD.000.0013.0		<b>wienet</b>	34
ZD.000.0014.0		<b>wienet</b>	34
ZD.000.0015.0		<b>wienet</b>	34
ZD.000.0016.0		<b>wienet</b>	34



# Pluggable installation solutions from Wieland

## Additional information

### Technical support

#### Automation technology:

■ Safety technology **safety**

Phone: +49-9 51 93 24-999

e-mail: [safety@wieland-electric.com](mailto:safety@wieland-electric.com)

■ **interface**

Power supply, industrial Ethernet switches, timer relays, measuring and monitoring relays, coupling relays, analog modules, remote I/O, surge protection, passive interfaces, remote power distribution **podis**<sup>®</sup>

Phone: +49-9 51 93 24-995

■ DIN rail terminal blocks **fasis, selos**

industrial multipole connectors **revos**  
PCB terminals and connectors **wiecon**,  
appliance terminals, european terminal strips,  
 housings for electronic components

Phone: +49-9 51 93 24-991

Fax: +49-9 51 93 26-991

e-mail: [AT.TS@wieland-electric.com](mailto:AT.TS@wieland-electric.com)

### Hotline numbers Sales:

- Questions for Sales on availability, delivery schedules, and pricing

Phone: +49-951 9324-990

### Technical support

#### Building services engineering:

- System connectors for building installation

**gesis**<sup>®</sup>, **gesis**<sup>®</sup>RAN, **gesis**<sup>®</sup>ELECTRONIC

Phone: +49-9 51 93 24-996

- Photovoltaics **gesis**<sup>®</sup>SOLAR

Phone: +49-9 51 93 24-972

- DIN rail terminal blocks **fasis** BIT, **selos** BIT

Phone: +49-9 51 93 24-992

Fax: +49-9 51 93 26-996

e-mail: [BIT.TS@wieland-electric.com](mailto:BIT.TS@wieland-electric.com)

### Additional informations

#### for solar technology:

**gesis** SOLAR flyer

Part No. 0162.3

#### Information on pluggable installations:

**gesis** CON

Part No. 0600.1

**gesis** IP+

Part No. 0690.1

#### Dezentrale Elektronik-Verteiler:

**gesis** ELECTRONIC

Everything follows a system

Part No. 0700.1

**gesis** RAN

Part No. 0409.1

#### Information about Wieland products in general:

Wieland Product Overview

Part No. 0902.1

#### General information and news:

[www.wieland-electric.com](http://www.wieland-electric.com)

Visit our eCatalog at [wieland-electric.com](http://wieland-electric.com)





## Our subsidiaries

... and the addresses of our representations worldwide are available at:

[www.wieland-electric.com](http://www.wieland-electric.com)



**USA**  
**Wieland Electric Inc.**  
**North American Headquarters**  
 2889 Brighton Road  
 Oakville, Ontario L6H 6C9  
 Phone +1 905 8298414  
 Fax +1 905 8298413  
[www.wielandinc.com](http://www.wielandinc.com)



**CANADA**  
**Wieland Electric Inc.**  
**North American Headquarters**  
 2889 Brighton Road  
 Oakville, Ontario L6H 6C9  
 Phone +1 905 8298414  
 Fax +1 905 8298413  
[www.wieland-electric.ca](http://www.wieland-electric.ca)



**GREAT BRITAIN**  
**Wieland Electric Ltd.**  
 Riverside Business Centre,  
 Walnut Tree Close  
 GB-Guildford/Surrey GU1 4UG  
 Phone +44 1483 531213  
 Fax +44 1483 505029  
[sales.uk@wieland-electric.com](mailto:sales.uk@wieland-electric.com)



**FRANCE**  
**Wieland Electric SARL.**  
 Le Céramê Hall 6  
 47, avenue des Genottes  
 CS 48313  
 95803 Cergy-Pontoise Cedex  
 Phone +33 1 30320707  
 Fax +33 1 30320714  
[info.adv@wieland-electric.com](mailto:info.adv@wieland-electric.com)



**SPAIN**  
**Wieland Electric S.L.**  
 C/ Maria Auxiliadora 2 bajos  
 E-08017 Barcelona  
 Phone +34 93 2523820  
 Fax +34 93 2523825  
[ventas@wieland-electric.com](mailto:ventas@wieland-electric.com)



**ITALY**  
**Wieland Electric S.r.l.**  
 Via Edison, 209  
 I-20019 Settimo Milanese  
 Phone +39 02 48916357  
 Fax +39 02 48920685  
[info.italy@wieland-electric.com](mailto:info.italy@wieland-electric.com)



**POLAND**  
**Wieland Electric Sp. Zo.o.**  
 Św. Antoniego 8  
 62-080 Swadzim  
 Phone +48 61 2225400  
 Fax +48 61 8407166  
[office@wieland-electric.pl](mailto:office@wieland-electric.pl)



**CHINA**  
**Wieland Electric Trading**  
 Unit 2703  
 International Soho City  
 889 Renmin Rd.,  
 Huang Pu District  
 PRC- Shanghai 200010  
 Phone +86 21 63555833  
 Fax +86 21 63550090  
[info-shanghai@wieland-electric.com](mailto:info-shanghai@wieland-electric.com)



**DENMARK**  
**Wieland Electric A/S**  
 Vallørækken 26  
 DK-4600 Køge  
 Phone +45 70 266635  
 Fax +45 70 266637  
[sales.denmark@wieland-electric.com](mailto:sales.denmark@wieland-electric.com)



**BELGIUM**  
**ATEM – Wieland Electric NV**  
 Bedrijvenpark De Veert 4  
 B-2830 Willebroek  
 Phone +32 3 8661800  
 Fax +32 3 8661828  
[info.belgium@wieland-electric.com](mailto:info.belgium@wieland-electric.com)



◀ Informational material for ordering and for downloading from our websites

Subject to technical modifications!

**gesis**®, **podis**®, **samos**® are registered trademarks of Wieland Electric GmbH



# wieland

Headquarters:

Wieland Electric GmbH  
Brennerstraße 10 – 14  
96052 Bamberg, Germany

Sales and Marketing Center:

Wieland Electric GmbH  
Benzstraße 9  
96052 Bamberg, Germany

Phone +49 951 9324-0

Fax +49 951 9324-198

[www.wieland-electric.com](http://www.wieland-electric.com)

[www.gesis.com](http://www.gesis.com)

[info@wieland-electric.com](mailto:info@wieland-electric.com)

## Industrial technology

### Solutions for the control cabinet

- DIN rail terminal blocks
  - Screw, tension spring or push-in connection technology
  - Wire cross sections up to 240 mm<sup>2</sup>
  - Numerous special functions
  - Software solutions interfacing to CAE systems
- Safety
  - Safe signal acquisition
  - Safety switching devices
  - Modular safety modules
  - Compact safety controllers
  - Application consulting and training
- Network engineering and fieldbus systems
  - Remote maintenance via VPN industrial router and VPN service portal
  - Industrial Ethernet switches
  - PLC and I/O systems, standard and increased environmental conditions
- Interface
  - Power supply units
  - Overvoltage protection
  - Coupling relays, semiconductor switches
  - Timer relays, measuring and monitoring relays
  - Analog coupling and converter modules
  - Passive interfaces

### Solutions for field applications

- Decentralized installation and automation technology
  - Electrical installation for wind tower
  - Fieldbus interfaces and motor starters
- Connectors for industrial applications
  - Rectangular and round connectors
  - Aluminum or plastic housings
  - Degree of protection up to IP68
  - Current-carrying capacity up to 100 A
  - Connectors for hazardous areas
  - Modular, application-specific technology

### PC board terminals and connectors

- Screw or spring clamp connection technology
- Spacings: 3.5 mm to 10.16 mm
- Reflow or wave soldering process

## Building and installation technology

- Building installation systems
  - Main power supply connectors IP20/IP65...IP68
  - Bus connectors
  - Low-voltage connectors
  - Power distribution system with flat cables
  - Distribution systems
  - Bus systems in KNX, LON and wireless technology
  - DIN rail terminal blocks for electrical installations
  - Overvoltage protection

0710.1 C 06/13

contacts  
are  
green.