



48V Household Energy Storage System UNIVERSAL 4K4

Product manual HESU Max 5 units in Parallel Max 5 Clusters

Model type HeSU UNIVERSAL STACKABLE UNITS

BMS-CAN V3.0

Version: V1.07.1-November 2019





ATTENTION: The battery can explode under heavy impact.



ATTENTION: The batteries weight exceeds 25kg. Appropriate mechanical lifting equipment must be used.



ATTENTION: The battery can explode and must not be exposed to open flames or other extreme sources of heat



ATTENTION: The battery terminals must be disconnected before commencing any work on the battery.



ATTENTION: This battery can accumulate parasite current. Do not touch the B+ and B- terminals. Always check the B+ and B- terminals with a voltmeter. Always ensure that there is ZERO volts present on the terminals before performing any operation on the battery.

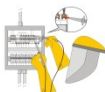

ATTENTION: Always wear Individual protection devices and follow the safety plan of the

ATTENTION: Battery must be recycled by professional company

LITHIUM END LIFE PROGRAM FREE OF COSTS



cobat[®]



TABLE OF CONTENTS

STATEMENT		5
1	PREFACE	6
2	INFORMATION IN THIS MANUAL	6
	2.1 About this Manual	6
	2.2 Use Range	6
	2.3 Additional Information	6
	2.4 Symbols Used	6
3	SAFETY	7
	3.1 Warnings and Notification	7
	3.2 Safety Guidelines	7
4	PRODUCT OVERVIEW	8
	4.1 Product Introduction	8
	4.2 Identifying the Product	8
	4.3 Product Identification Labels	8
5	SYSTEM INSTALLATION	9
	5.1 Installation Notice	9
	5.2 Package Information and Parts List	9
	5.3 Installation Procedure	12
	5.4 Communication and Control Panel	18
	5.5 DIP Switch Settings	19
	5.6 Parallel Battery Wiring Connections	21
6	BATTERY ACTIVATION AND SHUTDOWN	24
	6.1 Panel Button and LEDs Explanation	24
	6.2 Stand Alone Battery Front Panel Control	24
	6.2.1 Start Battery	24
	6.2.2 Shut Down Battery	24
	6.2.3 Low battery Forced Charge Function	24
	6.3 Parallel Battery Configuration	25
	6.3.1 Activation of Parallel Batteries	25
	6.3.2 Shut Down of Parallel Batteries	25
7	TROUBLESHOOTING	26
8	SOFTWARE GUIDE	28
9	PRODUCT COMPATIBILITY LIST (See Also 8.5)	32
10	SINGLE CLUSTER CONFIGURATION GUIDE (100A)	33
11	SINGLE CLUSTER CONFIGURATION GUIDE (300A)	36
12	MULTI CLUSTER HUB CONTROLLER	39
13	MULTI CLUSTER CURRENT LIMITATIONS	43
14	MULTI CLUSTER CONNECTION CONFIGURATIONS	45
15	INVERTER SETTINGS	48



Statement:

The following statement is related to the product 4K4 HeSU Stackable Version.

In case of product upgrades or other reasons, this document will be adjusted accordingly. Unless otherwise agreed, this document is intended to be used only as a guide, and all statements, information and advice in the documentation shall not constitute any express or implied action in contradiction to local regulations or standards.

For more information, please contact us.

The official information and the latest datasheet are available on www.wecobatteries.com

It is essential that the battery unit is equipped with the latest firmware version available.

WeCo will release new firmware to improve the functionalities and battery capabilities from time to time

The latest version of the firmware is always available free of charge, the battery firmware can be updated by your local installer.

You can also write an email to weco@weco.uk.com to understand the upgrade procedure.



ATTENTION

This battery model is designed to be used indoors

The STANDARD IP20 degree of protection does not allow installation in outdoor environments even if sheltered from the weather.

The INDOOR definition means literally the internal environment, the room must be closed to unauthorized persons, ventilated and dry.



1 PREFACE

Thank you for choosing our product. We will provide you with a good quality product as well as reliable after service.

To protect against harm to both personnel and the product, please read this manual carefully.

This manual provides detailed information on operation, maintenance and troubleshooting of the product as well as health and safety advice.

Special Announcement:

The manufacturer holds the right of final explanation of any content in this manual.

2 INFORMATION IN THIS MANUAL

2.1 About this Manual

This manual relates only to the HeSU 4k4 Low Voltage Universal Stackable Model. This manual is intended to be used only by qualified installers who must read carefully and always refer to the manual for guidance on correct operation and maintenance of the product.

2.2 Use Range

This installation guidance applies only to the HeSU 4k4 Low Voltage Universal Stackable Model.

2.3 Additional Information

Specification of the product can be changed without any notice to customers.

2.4 Symbols Used

Symbol meanings:



CAUTION:

CAUTION represents hazardous situations which can cause light injuries if not avoided.



NOTICE:

NOTICE represents the situations which can cause damage to property if not avoided.



INFORMATION:

INFORMATION provides tips that are valuable for optimum installation and operation of the product.



3 SAFETY

3.1 Warnings and Notification

Installation environment requirements: -HESU- SERIES is designed for household purposes. For installation, it must be installed in a location complying with IP20. (IP 55 or IP65 are available on request). Installations in locations that do not comply with IP20 may cause failure and/or damage to the product and subsequently the product warranty will be considered void.

3.2 Safety Guidelines



CAUTION:

At all times be certain to avoid a short-circuit between the anode terminal and a cathode terminal of the battery. All electrical connections on the -HESU- SERIES must be made only by qualified professional personnel.

When installed and operated in accordance with this manual, the HeSU Series battery will perform as a safe and reliable manner in accordance with the battery operating specifications.

Subjecting the battery to an unsuitable operating environment or to damage, misuse or abuse may result in health and safety risks such as overheating or electrolyte smoke potential. All personnel must comply with the safety precautions and observe all warnings as detailed in this document. If any of the safety precautions or procedures detailed in this manual is not fully understood by the reader, the reader must not perform any operation on the battery, until they have contacted WECO the customer service officer for clarification and confirmation of understanding of the correct procedure.

The safety guidelines included in this document may not include or consider all the regulations in your area of installation/operation. When installing and operating this product the installer must review and consider applicable local laws and regulations in accordance with the industry standards of the product.

Installation personnel shall not wear watches and other metal items when performing installations as a precaution to avoid short circuits and personal injuries.



CAUTION:

The weight of an individual HeSU 4k4 battery is around 50kg, please use original packaging and perform all safety precautions if the battery is to be relocated to another location, to avoid damage to the product and personnel injury.



4 PRODUCT OVERVIEW

4.1 Product Introduction

The HeSU Series batteries can be used as an on-grid or off-grid energy storage system. It is recommended not to use this product for any purpose other than the intended purpose as described in this document.

Use of this product other than as described in this document will nullify the product guarantee. The substitution or installation of any components of this battery will nullify the product guarantee.

The use of any components contained within or connected to this battery other than the products sold as part of this product or recommended by the manufacturer will nullify the product guarantee.

Connecting more than five individual HeSU 4k4 battery units in parallel will nullify the product guarantee.

4.2 Identifying the Product

Model	HeSU 4K4 - R19/4
Voltage	Low Voltage (STD 48Vdc)
Operative voltage	46.3-57.8Vdc
Max - cut out/ cut off -	44-58.8Vdc
Nominal capacity	85Ah
Net Energy	4.45 kWh
Cell type	LFP O-Li
Power output	5kW
Nominal Power	3kW
Expected cycles @ STC	7000
Nominal current Input/output BMS	-70A / +60A
Operative temperature in discharge	-20°C + 60°C
Net Weight	53 kg
Installation mode	Wall or floor mounted
Operational expectation up to:	15 years
Stock period without recharge	2 years from the production date and in the Temp. range of -20°C + 50°C
Display	RUN, LOWBAT, FAULT with LED
Accessories	Data cable: CAN RJ45/RJ45, RJ45/RJ85, RS 232, RS 485 AWG cable: 100 cm with ring terminal (RED/BLACK) Earthing cable: Single core yellow/green with ring terminal
Standards	IEC 61600-6-3: 2017 61600-3-2:2014 61000-3-3:2013 61600-6-2007 CE UN 38.3
Enclosure	Steel
Warranty	10 years
IP grade	IP20 (IP 65 on request)
Recycle program	
Legal information	The technical specifications contained in this document are subject to change without notice. The cobat Logo is the exclusive property of the cobat consortium and has no corporate ties with WeCo or the Group's companies. The recycling and withdrawal at the battery's "end life" is regulated by the National Convention stipulated with cobat . Management and programming software are released for temporary use. The firmware released by WeCo for implementation of the functions and security, must be installed by qualified installers. The terms of sale and warranty terms are published on the website.



4.3 Product Identification Labels

The nameplate label attached to the product describes the product parameters, including model type and serial number. Installers must always check that the specifications displayed on the nameplate of the battery module relates to the installation manual that is being referred to for guidance.

Only qualified personnel, with a comprehensive understanding of this manual are permitted to install this product.

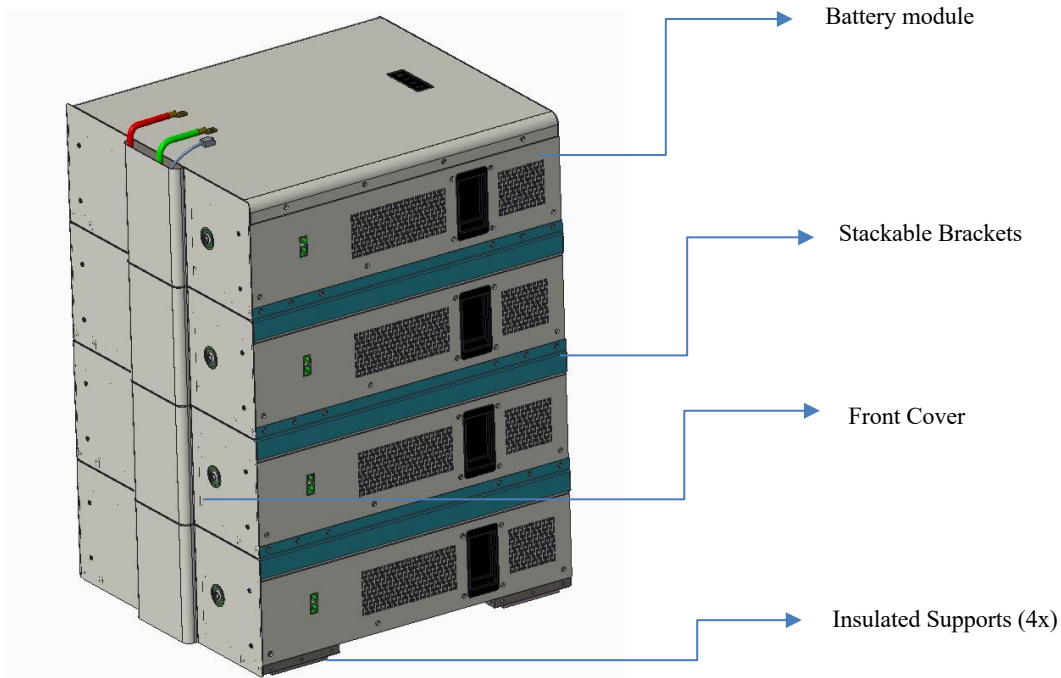



5 SYSTEM INSTALLATION

The battery is packed in a carton box. The total weight exceeds 50Kg and as such it is mandatory that the opening, unpacking and preliminary checking of the battery is conducted by carried out by a minimum of two people.

5.1 Installation Notice

- a) Before installation, check the battery open circuit voltage.
- b) Battery installation location should be at least 20m away from sources of heat, sparks or other sources of extreme temperature.
- c) Battery connecting cables should be as short as possible to prevent excessive voltage drops.
- d) Batteries with different capacity, different P/N or from different manufactures must never be connected together.
- e) Before connecting the battery, the battery positive and negative poles need to be carefully checked to ensure correct installation.
- f) The battery should be installed on a horizontal plane.









5.2 Package Information and Parts List

The battery is packed in a carton together with standard accessories. When unpacking the battery, be sure to check that the battery and accessories are free from damage and that the correct quantities of each component are included within the carton.

The following list of components can be used as a check list when unpacking the individual battery and battery kits.

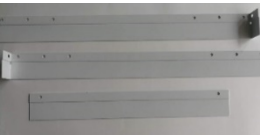









5.2.1 Parts list (Standard Kit 100A)

Number	Name	Quantity	Description	Image
1	Battery case	1-5	Battery	
2	Short power cable (Stack KIT)	1+1	Positive and negative Ring terminal connection	
3	Fixed front screws (Stack KIT)	4	Screws 5x35	
4	CAN cable RJ45 Parallel Connection (provided with the battery)	1	100cm	
5	Stack Brackets + M4 screws (Stack KIT)	3	1 kit x 3 each box + screws	
6	Front Panel (Stack KIT)	1	1 kit	
7	Supports (Stack KIT)	4	1 kit x 4 each box + screws	
8	BMS/STD		1 BMS std Cable 100cm	



5.2.2 Recommended Installation Tools

 <p>Multimeter + Current clamp</p>	 <p>Screw Driver Set</p>	 <p>Allen Key Set</p>	 <p>Drill + Hammer</p>
 <p>Electrician Scissors</p>	 <p>Wrench set</p>	 <p>Lifting strap + mechanical lifter</p>	 <p>RS 232/USB+screw terminal (insulated)</p>

5.2.3 Personal Protective Equipment





5.3 Installation Procedure

5.3.1 Battery Controls and Connections

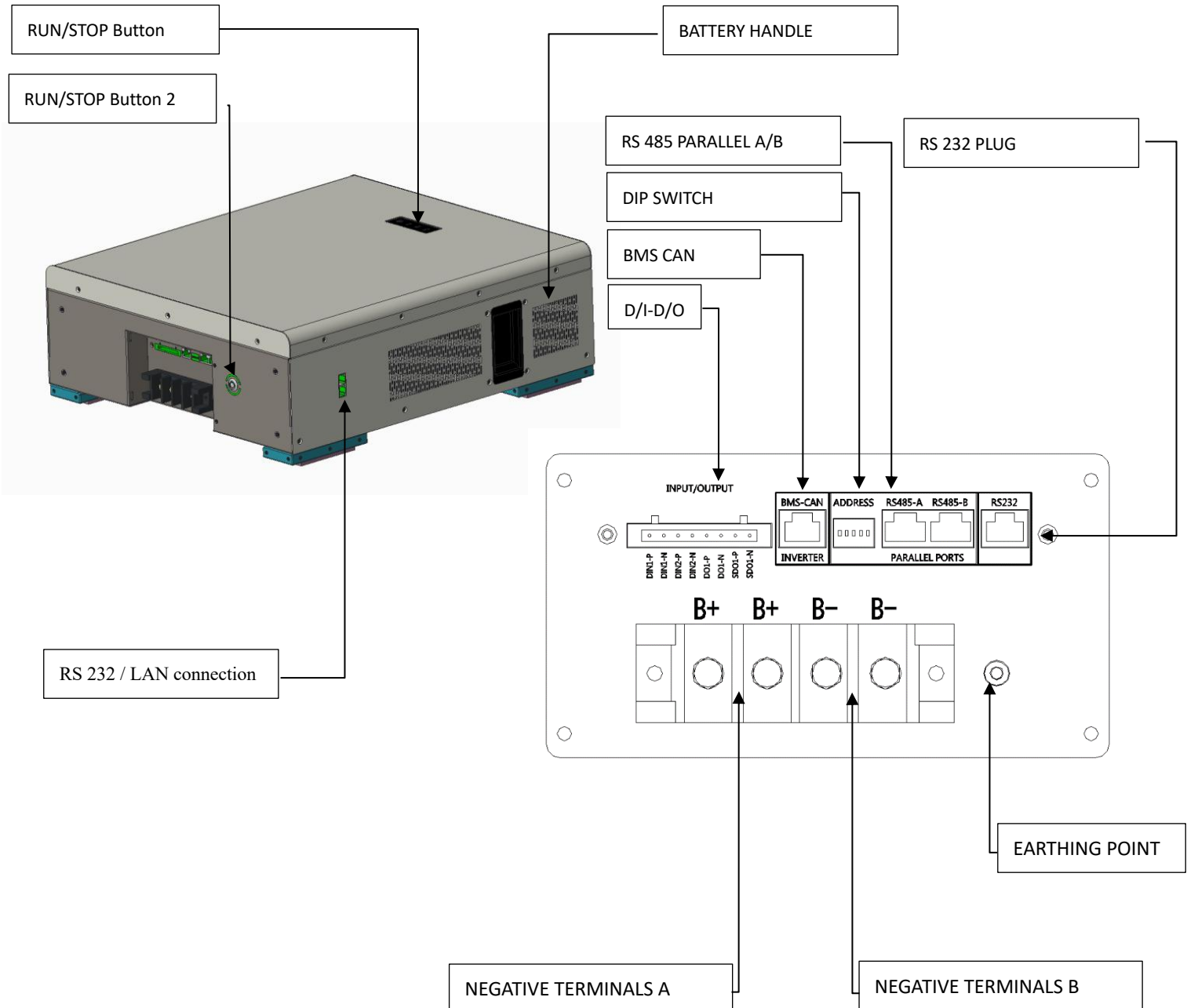



5.3.2 Installation/Assembly Method

5.3.2.1 Installation of accessories and preparatory phases

Phase 1: Choose the support surface carefully, the batteries have a weight of over 50 kg each and can reach 270 kg including the accessories, in a stack of five batteries.

The surface profile of the battery on the ground is 55cm x 46cm but the actual contact with the ground is made by 4 supports of about 4x10 cm each.

Make sure the support surface is adequate to support the overall battery load.



Information :

Preparation of the modules

The battery is delivered as standard in a **WALL MOUNT CONFIGURATION** and it is therefore necessary that the installer make simple external changes to install the **STACK KIT**.

STACK MOUNT INSTALLATION PHASES FOLLOW

1. Install the support feet on the back of the battery using the supplied screws. Each foot must be installed with 2 M8 Allen screws supplied. Repeat the operation for all the batteries you want to stack.

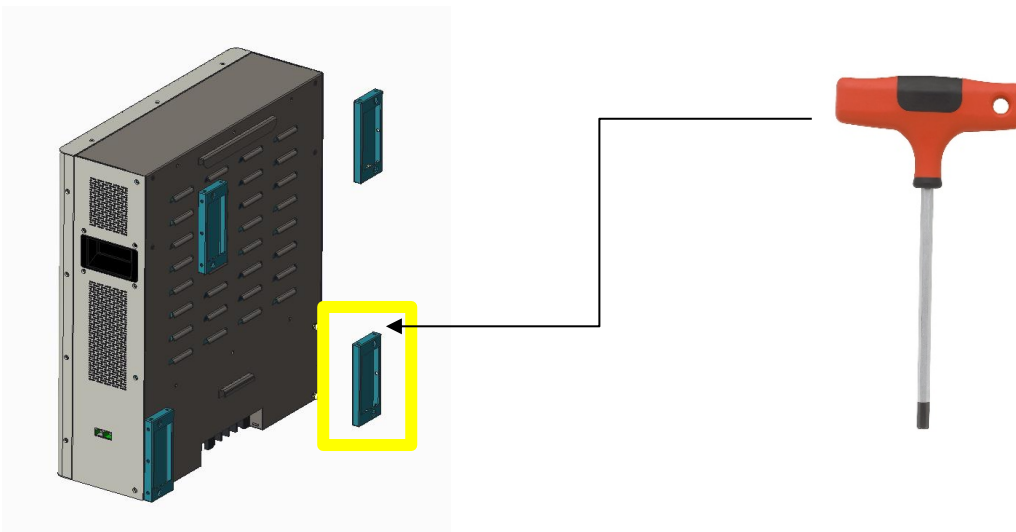



2. Once the support feet have been installed, place the first battery on the ground surface in and check that the battery is even and that all four feet are making connection with the ground surface.
Next, install the four feet on the bottom of the second battery and place the second battery on top of the first battery. Check that the second battery is aligned with the first battery and that all feet are making contact with the first battery.

2. Once each battery has been installed in the horizontal position the feet which shipped with the battery in standard configuration can be removed as they are no longer required.

3. With the second battery correctly positioned on top of the first battery you must install the perimeter alignment brackets, two at the sides and one at the back.

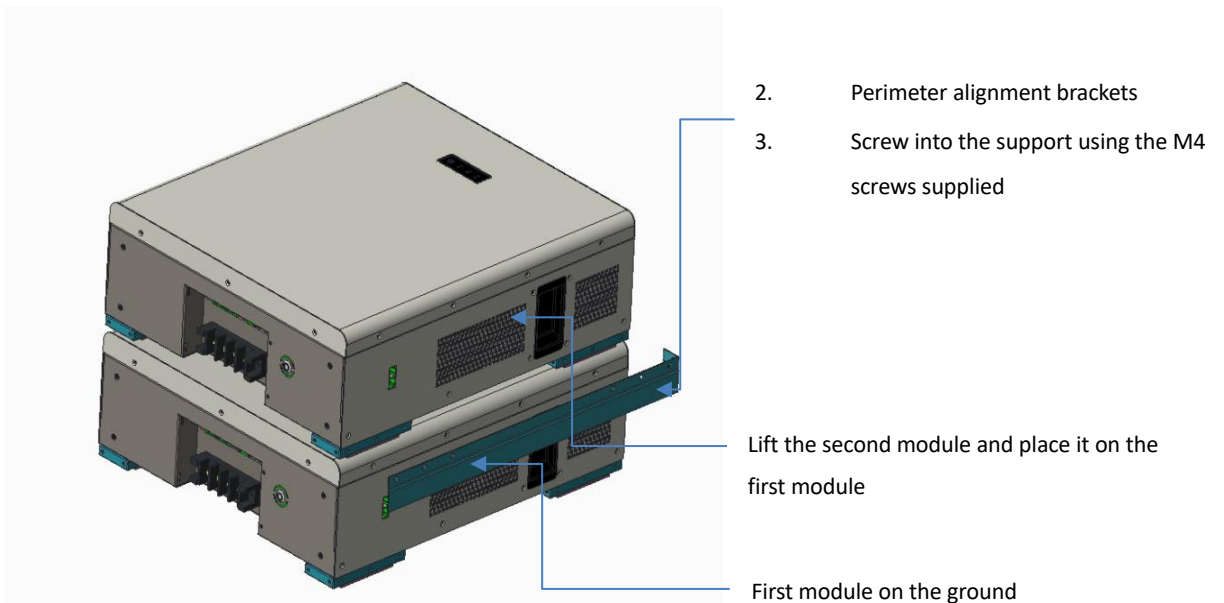



- Continue installation of the three perimeter support brackets to ensure that the second battery is securely installed on top of the first battery.



CAUTION

Each battery weighs more than 50kg and must be installed with the help of a mechanical lift, and / or with at least two people equipped with suitable suction cups for lifting or lifting straps

- Continue the installation with the desired quantity of modules following the sequence described in points 1 through 5.





4.  **MAKE SURE THAT THERE IS ZERO VOLTAGE ON THE BATTERY TERMINALS. CHECK THE LED BUTTON ON THE BOTTOM AND ALWAYS MEASURE THE B+ AND B- TERMINALS WITH A MULTIMETER.**

Once it has been verified that there are ZERO volts present ON ALL BATTERIES, proceed with the installation of the cables as shown in the diagram below.

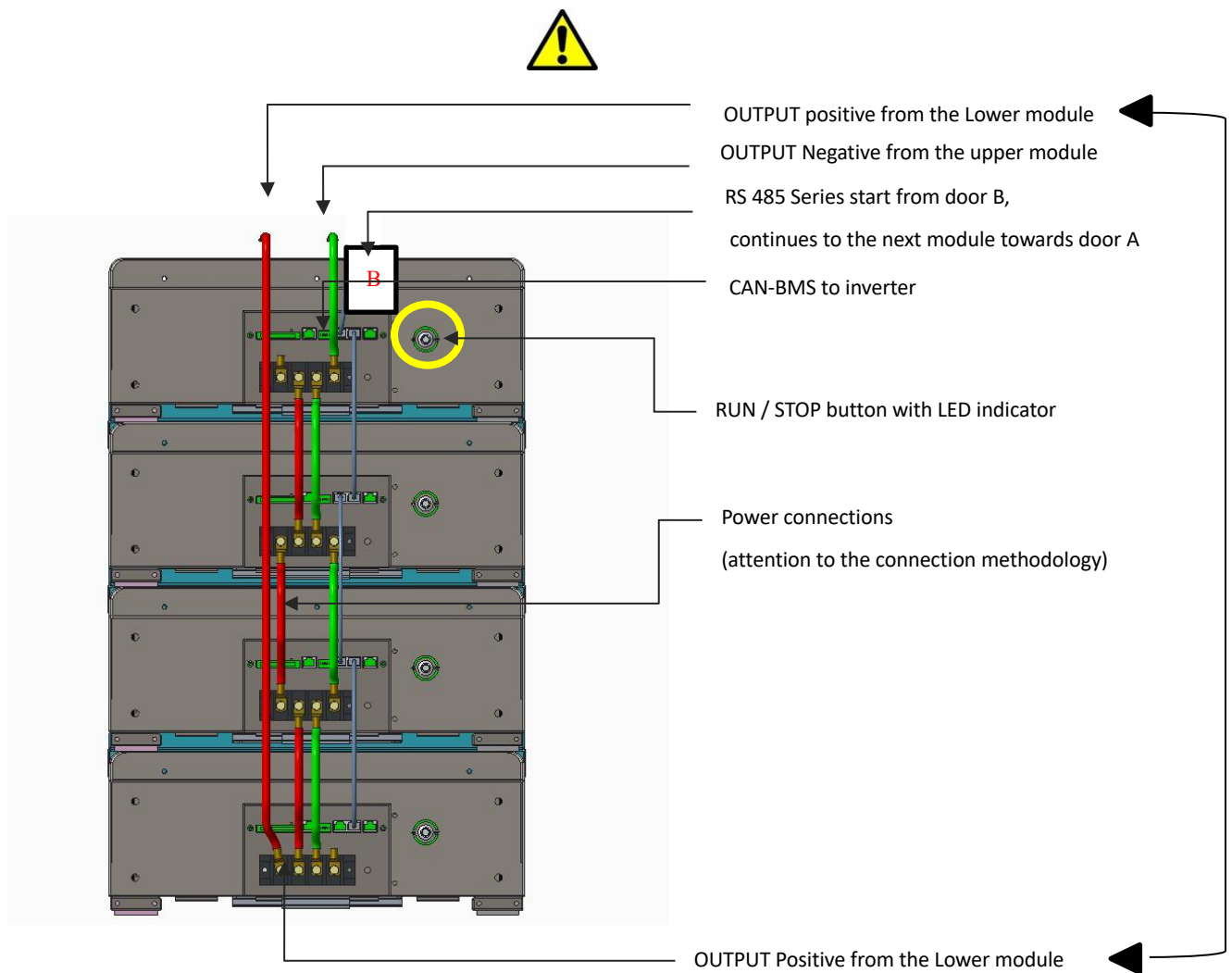



5. After all cables have been connected, install the front plate protective covers as shown below.

Always start at the bottom and work up to the top.

Always install cables in accordance with installation guidelines and avoid long cable runs to prevent excessive voltage drops

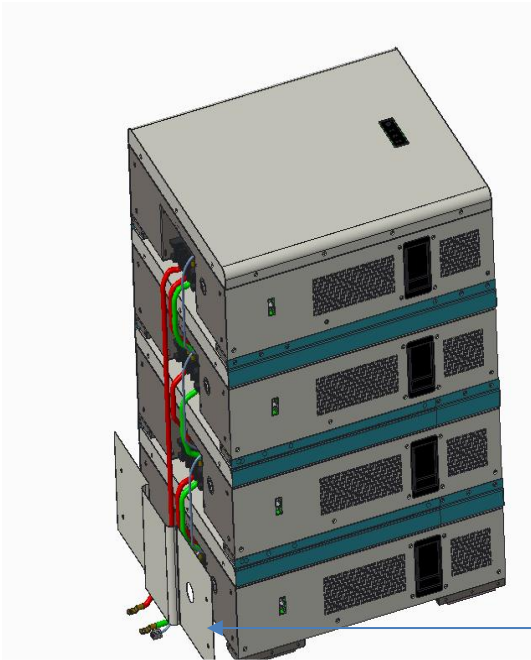

Install the plate using the supplied M8 Allen screws



Note that the output position of the cables is only indicative and can vary with each installation

6. The complete installation for the battery stack can be seen below.

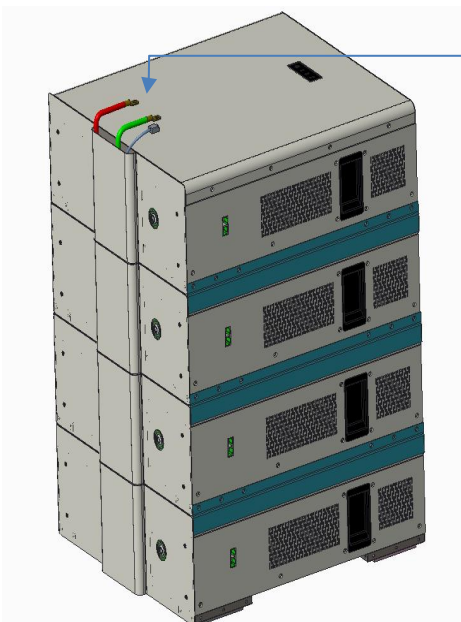

Output position of the power cables and recommended CAN cable



5.4 Communication & Control Panel

5.4.1 Terminal Function and Definition

The terminal layout is shown in the following figure:

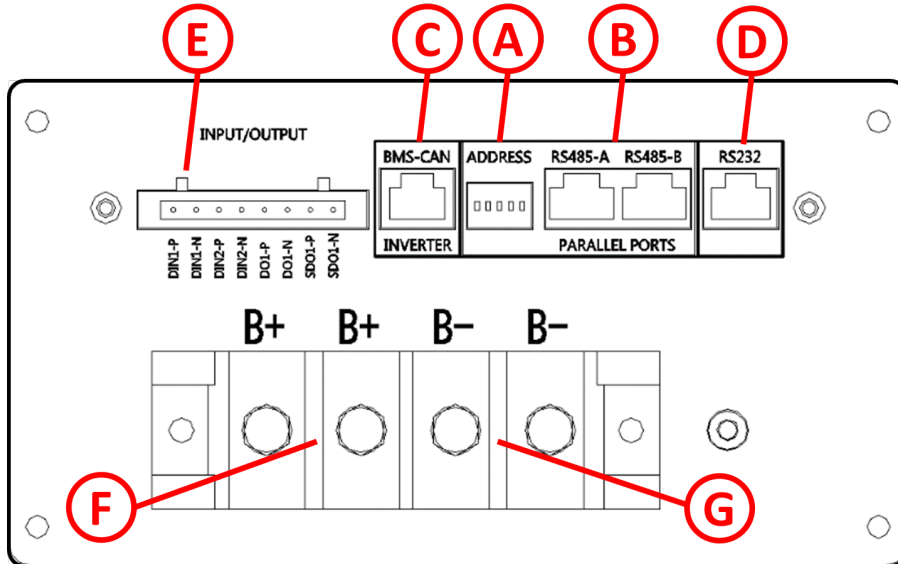

Wiring definition table		
Interface	Name	Function
A	ADD	DIP switch, set the RS485 address and terminal resistance.
B	RS485-A RS485-B	When the battery is installed as stand-alone it can communicate with the inverter via RS485 interface. When the battery is installed in parallel, the RS485 interface is used for synchronous communication between battery packs.
C	CAN	CAN bus interface communicates with the inverter.
D	RS232	RS232 interface is used for monitoring battery real-time data and troubleshooting. (laptop Connection)
E1	DIN1-P	IO port, interacts with a diesel engine, a photovoltaic device, or other external device.
E2	DIN1-N	
E3	DIN2-P	
E4	DIN2-N	
E5	DO1 -P	
E6	DO1-N	
E7	SDO1-P	
E8	SDO1-N	
F	B+/B+	Battery positive
G	B-/B-	Battery negative

Attention: Interface-C is an RJ45 Port corresponding to the CAN Bus pin definition shown below

8 1	Pin	8	7	6	5	4	3	2	1
	Definition						GND	CAN L	CAN H



5.5 DIP Switch Settings



ATTENTION

ALWAYS CONFIGURE THE DIP SWITCH SETTINGS BEFORE CONNECTING ANY POWER CABLES TO THE BATTERY TERMINALS B+ AND B-.

WHEN CHANGES HAVE BEEN MADE TO DIP SWITCH SETTINGS THE BATTERIES MUST ALWAYS BE RESTARTED FOR THE CHANGES TO TAKE EFFECT.

WHEN THE INVERTER HAS A CANBUS COMMUNICATION PORT SWITCH#5 OF THE MASTER BATTERY MUST ALWAYS BE SET TO “ON”.

5.5.1 Stand Alone Battery



MASTER (INDIVIDUAL)

5.5.2 (Master + Slave#1)

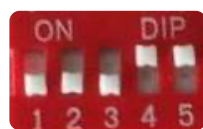

MASTER



SLAVE#1



5.5.3 (Master + Slave#1 + Slave#2)



5.5.4 (Master + Slave#1 + Slave#2 + Slave#3)

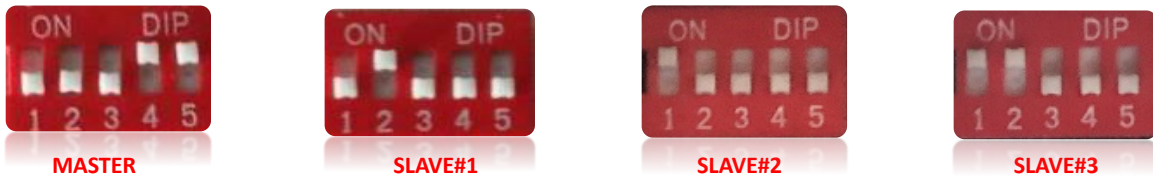

5.5.4 (Master + Slave#1 + Slave#2 + Slave#3 + Slave#4)



ATTENTION

ALWAYS CONFIGURE THE DIP SWITCH SETTINGS BEFORE CONNECTING ANY POWER CABLES TO THE BATTERY TERMINALS B+ AND B-.



5.6 Parallel Battery Wiring Connections



ATTENTION

PARALLEL BATTERY INSTALLATION MUST FOLLOW THE WIRING CONNECTIONS SHOWN IN THIS SECTION

A WRONG WIRING CONNECTION CAN DAMAGE THE BATTERY AND POTENTIALLY CAUSE PERSONNEL INJURIES

 **40 Nm** Power cable Tighten

CHECK EVERY THREE MONTHS

THE DRAWINGS IN THIS MANUAL ARE FOR REFERENCE ONLY. IF THE DRAWINGS IN THIS MANUAL DO NOT MATCH THE ACTUAL PRODUCT THAT IS BEING INSTALLED, DO NOT PROCEED. ENSURE THAT THE BATTERY IS ISOLATED, ALL CONNECTIONS REMOVED, STORE THE BATTERY IN A SAFE PLACE AND CALL WECO PRODUCT ASSISTANCE FOR SUPPORT.

FOR MAX CHARGE AND DISCHARGE CURRENT REFER TO THE TABLES IN THE NEXT SECTION OF THIS MANUAL

BATTERIES IN THE STACK COMMUNICATE WITH EACH OTHER USING THE RS485 CONNECTORS

MASTER BATTERY COMMUNICATES WITH INVERTER USING THE CANBUS PORT



DIAMETER 25mm CABLE PARALLEL CONNECTION DIAGRAM OVERVIEW

THE DRAWINGS IN THIS MANUAL ARE FOR REFERENCE ONLY. IF THE DRAWINGS IN THIS MANUAL DO NOT MATCH THE ACTUAL PRODUCT THAT IS BEING INSTALLED, DO NOT PROCEED. ENSURE THAT THE BATTERY IS ISOLATED, ALL CONNECTIONS REMOVED, STORE THE BATTERY IN A SAFE PLACE AND CALL WECO PRODUCT ASSISTANCE FOR SUPPORT.

5.6.1 Master + Slave#1

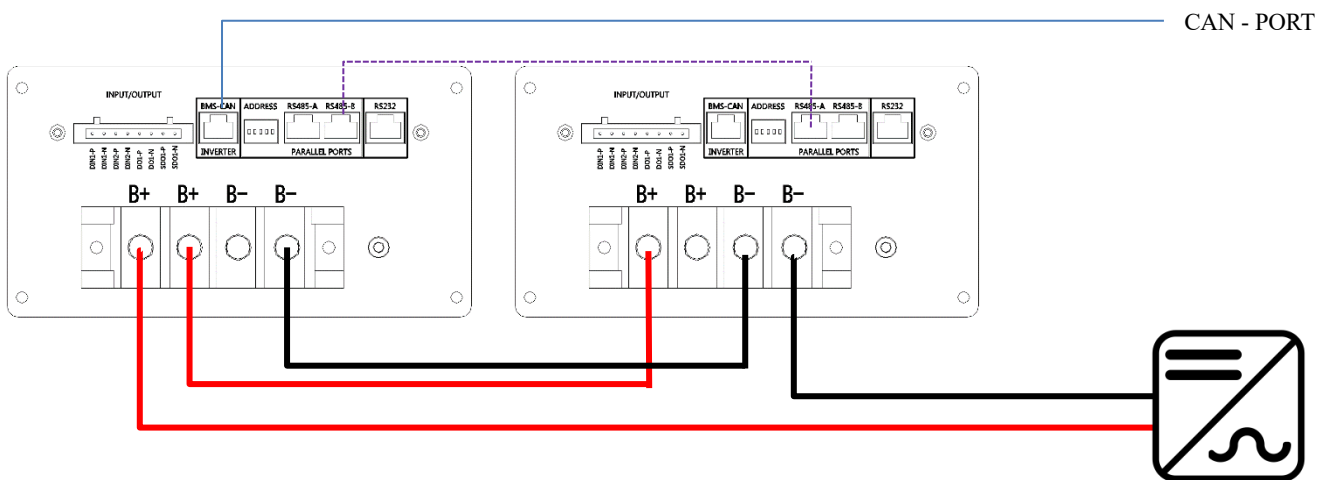

5.6.2 Master + Slave#1 + Slave#2

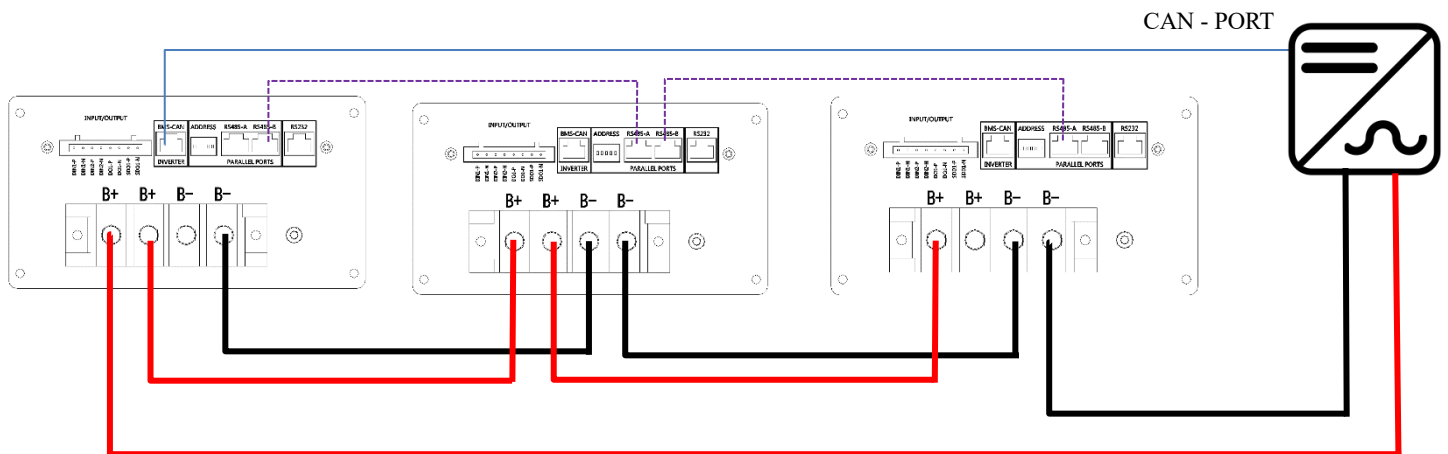



5.6.3 Master + Slave#1 + Slave#2 + Slave#3

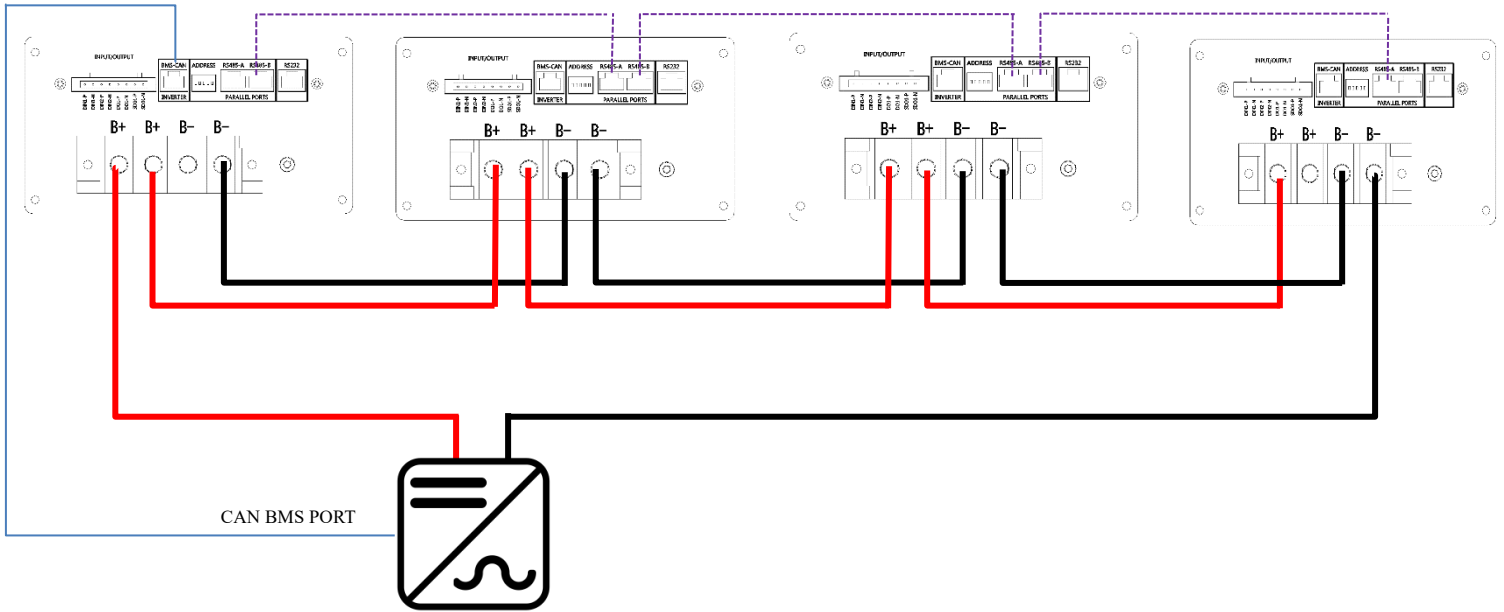

5.6.4 Master + Slave#1 + Slave#2 + Slave#3 + Slave#4

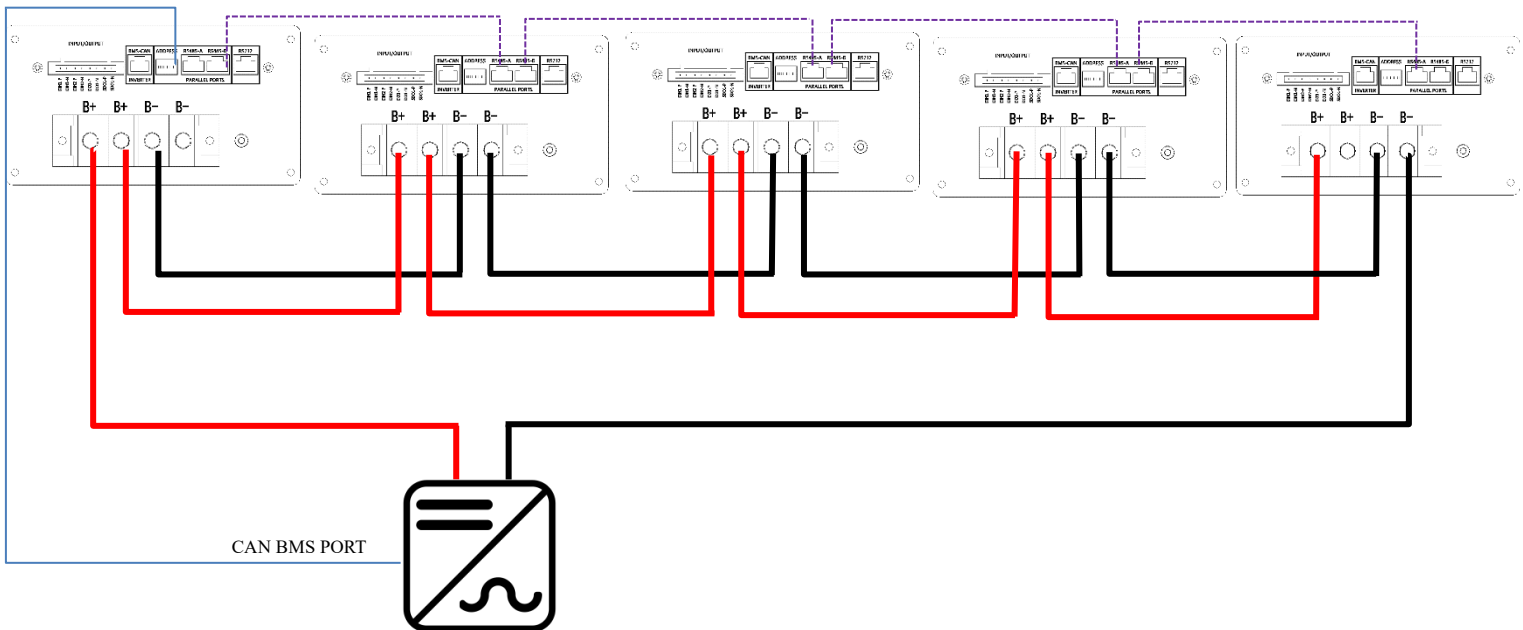



6 BATTERY ACTIVATION AND SHUTDOWN

6.1 Panel buttons and LEDs Explanation

Attention: The drawing is for reference only. If the actual battery has a different configuration. Stop all installation activity, ensure that the battery is disconnected and in a safe condition and contact WECO support center

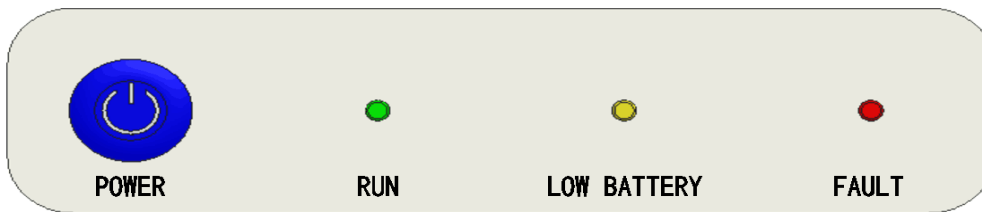

Name	Meaning	Function or indication status
POWER	Turn on or off button	Control battery box on or off
RUN	Running indicator light (green)	When the battery box is running normally, it always bright
LOW BATTERY	Low battery indicator (yellow)	When the battery is low(SOC<0-10%), it is always bright.
FAULT	Fault indicator light (red)	Flashing alarm when the battery box is faulty

6.2 Stand Alone Battery Front Panel Control

6.2.1 Start Battery

Short press the power button for one second. The GREEN RUN light should come on. The battery has been activated normally.

6.2.2 Shut Down Battery

Long press the power button for five seconds. The GREEN RUN light should go off. The battery has been shut down normally.

6.2.3 Low Battery – Force Charge

Prerequisite: The **VOLTAGE** between the battery B + and B- terminals is **ZERO** and the **PANEL LIGHTS ARE OFF**. Battery is in “Shutdown State”.

Preparation condition before forced charging: Connect the charger or the inverter with charging capability to the B+ and B- of the battery box to ensure charging capacity.

Forced charging approach: Short press the battery power button, the battery RUN light will flash green, which means that the battery is entering the compulsory charging mode. If the battery receives an adequate charging power (above 10 Amps/58V) within 90 seconds from pressing the button, the battery will continue to charge normally until a stable state is reached.

If the battery does not receive adequate charging power within 90 seconds after pressing the button, the battery will enter the shutdown mode once again.

During the forced charging period the low battery LED will be steady orange up to an SOC of 10% at which point the low battery LED will go out.



6.3 Parallel Battery Configuration

1. The voltage difference between any of the batteries in the stack must not be greater than 2V. Otherwise, the BMS will not allow the batteries to be activated in a parallel connection.
2. SOC of each battery in the stack must be the same (check SOC as individual battery before parallel connection)
3. The power cabling between the batteries is in accordance with section 5.6 of this manual.
4. All DIP switches are configured in accordance with section 5.5 of this manual.
5. The RS 485 inter battery data connections are properly connected as per section 5.6 of this manual. The data connection “daisy chain” must start from port-B of the master battery (do not install the RS485 on the port-A of the master battery, it will occur in a fault)
6. Connect the CAN port of the master battery with the CAN port of the inverter and make sure that the communication is working properly by checking the inverter display
7. Before activating the system, the operator should check the cable connection carefully and make sure that all safety procedures are respected. Check the inverter settings and connection before turning on. In case of an inverter without communication make sure to set the voltage and current value as per the charge/discharge parameters provided in this manual.

6.3.1 Activation of Parallel Batteries (From Master to Slave#4)

Short press the Master power button for one second. The GREEN RUN light should come on. The battery has been activated normally.
Short press the Slave#1 power button for one second. The GREEN RUN light should come on. The battery has been activated normally.
Short press the Slave#2 power button for one second. The GREEN RUN light should come on. The battery has been activated normally.
Short press the Slave#3 power button for one second. The GREEN RUN light should come on. The battery has been activated normally.
Short press the Slave#4 power button for one second. The GREEN RUN light should come on. The battery has been activated normally.
Now all parallel batteries are activated normally and the parallel system is properly powered on.

6.3.2 Shutdown of Parallel Batteries

Long press the Master Power button for five seconds. The GREEN RUN light should go off immediately.
The GREEN RUN lights on the slave batteries will not be extinguished immediately.
The RED FAULT lights on the slave batteries will start flashing after ten seconds and the GREEN RUN lights will remain on.
After one minute the RED Fault lights and the GREEN RUN lights on all slave batteries will go off.
The parallel battery system has shutdown properly.



NOTICE:



In a parallel battery system, we strongly advise not to switch off individual slave batteries. If there is a reason to switch off a slave battery, we recommend that the procedure described in 6.3.2 of this manual is followed.
Switching off an individual slave battery in a parallel system is possible in an adverse situation, but only as a last resort.



7 TROUBLESHOOTING

No.	ALARM	SYMPTOM	SOLUTION	GREEN (NORMAL) ORANGE (WARNING) RED (FAULT)
1	OVER CURRENT ALARM	The battery relay is disconnected during charging or discharging, and the battery fault light is flashing.	Reduce charge or discharge current	Disch_Ov_Cur warn: Ch_Ov_Cur warn:
2	OVER TEMPERATURE ALARM	The battery relay is disconnected during charging or discharging, and the battery fault light is flashing.	Stop charging or discharging, wait until the battery temperature drops and then reuse	Ch_Ov_Temp alarm: Disch_Ov_Temp alarm:
3	LOW TEMPERATURE ALARM	The battery is unable to charge or discharge normally	Waiting for the temperature of the battery to rise to a suitable temperature before charging or discharging	Ch_Low_Temp alarm: Disch_Low_Temp alarm:
4	OVER VOLTAGE ALARM	The battery relay is disconnected when charging, and the battery fault light is flashing.	Stop charging and review and reset properly the inverter settings	Over Vol alarm:
5	LOW VOLTAGE ALARM	The battery relay is disconnected when discharging, and the battery fault light is flashing.	Stop discharging from battery. Charge the battery in accordance with the correct charging procedure.	Low Vol alarm:
6	RELAY DAMAGE	The battery is switched on, there is no alarm, but no voltage is present. The battery is switched off, there is no alarm, but voltage is present (always check for with voltage with a meter at all times)	Please contact the after-sales service, replace relay	When this sign is disconnected and green, the relay is disconnected; When this sign is connected and red, the relay is connected; Main Relay(Magnetic retention):
7	PROTECTION BOARD DAMAGE	The PC and the batteries RS232 connection is reliable, but the monitoring software cannot read the battery information and status.	Please contact the after-sales service, replace protection board.	

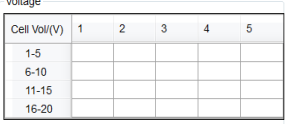

8	CELL DAMAGE	Battery box in the state of no charge and no discharge, a cell voltage and most of the other cells voltage difference greater than 200mV.	Please contact the after-sales service.	The real-time display of the cell voltage on the monitoring software is as follows:  <table border="1" data-bbox="1077 436 1364 560"> <thead> <tr> <th colspan="6">Voltage</th> </tr> <tr> <th>Cell Vol(V)</th> <th>1</th> <th>2</th> <th>3</th> <th>4</th> <th>5</th> </tr> </thead> <tbody> <tr> <td>1-5</td> <td></td> <td></td> <td></td> <td></td> <td></td> </tr> <tr> <td>6-10</td> <td></td> <td></td> <td></td> <td></td> <td></td> </tr> <tr> <td>11-15</td> <td></td> <td></td> <td></td> <td></td> <td></td> </tr> <tr> <td>16-20</td> <td></td> <td></td> <td></td> <td></td> <td></td> </tr> </tbody> </table>	Voltage						Cell Vol(V)	1	2	3	4	5	1-5						6-10						11-15						16-20					
Voltage																																								
Cell Vol(V)	1	2	3	4	5																																			
1-5																																								
6-10																																								
11-15																																								
16-20																																								
9	FIRST PARALLEL CONNECTION FAILURE OF BATTERIES	When the batteries are first paralleled, start the system, slave battery fault light flashing. No sound from the slave battery relay action, no voltage output.	Measure the positive and negative voltage of each battery, if the voltage difference between the batteries is greater than 2V, please reduce the voltage difference to less than 2V to try parallel connection	Pack Vol Imbalance: 																																				
10	MASTER-SLAVE MACHINE COMMUNICATION EXCEPTIONS	Slave battery fault light flashes, the master machine cannot control slave battery	Check that the communication cables between the master battery and the slave batteries are securely connected	slave1 online 																																				
11	BATTERY OR PARALLEL BATTERY SYSTEM SHUTDOWN CANNOT START	There is no alarm information in the battery, but the batteries are not working properly	Please contact the after-sales service																																					
12	OTHER EXCEPTIONS	Humidity, cell expansion, frost-Defrost, unbalances etc.	Please contact the after-sales service	FAULT RED																																				



FOR AUTHORIZED TECHNICIANS ONLY

8 SOFTWARE GUIDE

WECO OLP RS232 (USB / RS232 converter is necessary to communicate with the battery)

**_PC -Battery communication and set up for 232-USB device is available for auth. Installers.*

1. Launch the exe file WeCo_Monitor and wait for self installation

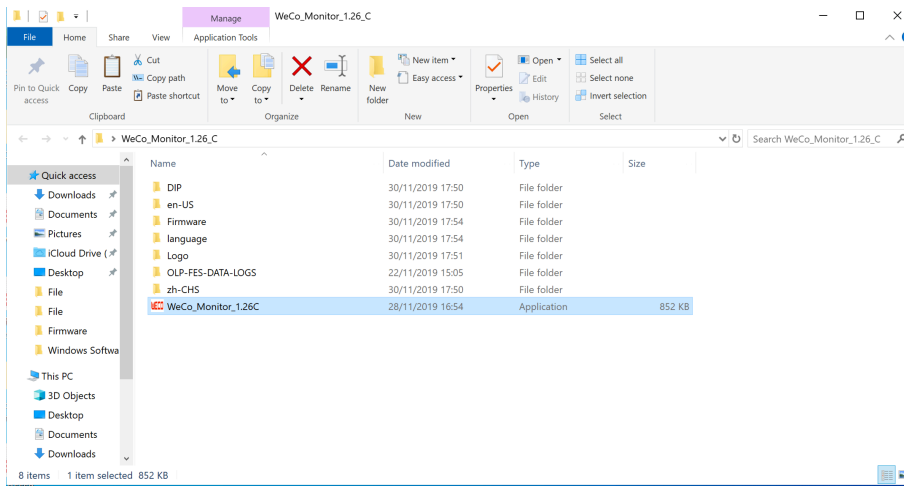

2. From the main page select USER FREE if you are not an authorized installer, if you have a 1st level password click on the RESTRICTED ACCESS windows and follow the 'Authorized Installer Guide'
If in possession of a valid password the authorised installer will be able to access more detailed windows within the software.





WeCo - HeSU 4K4 Low Voltage UNIVERSAL STACKABLE MODEL

3. Connect the RS232 converter and search the relative com on the PC settings (device manager of Windows_)
Select the COM port from the Main page of the WeCo Monitor, then pres CONNECT
Follow the instruction and wait for the data on the screen.

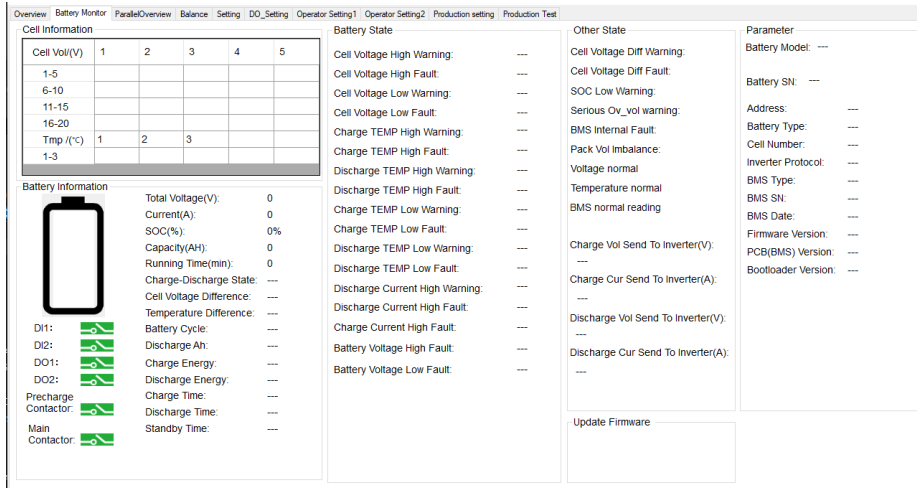
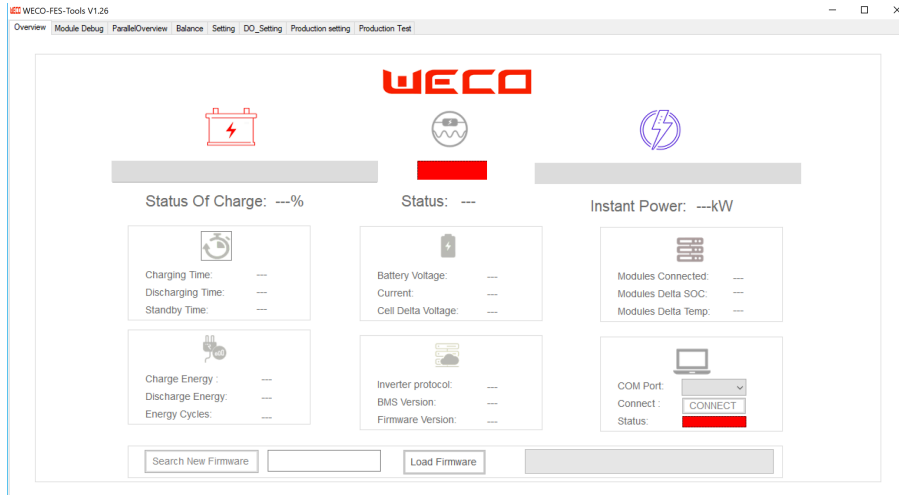

4. If more than one module is connected, select Parallel Overview and check the single unit data.

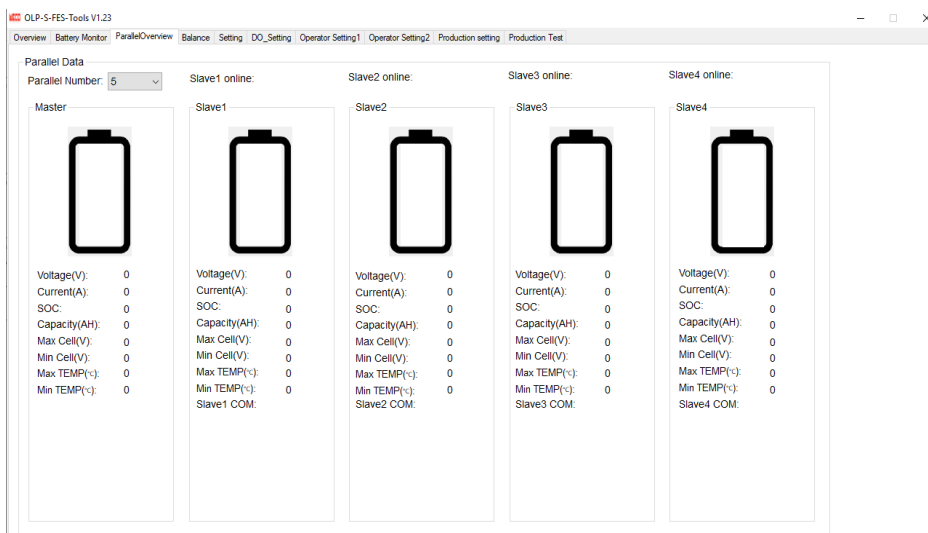



- 5. CAN protocol Setting, to match the inverter communication, select and press SET, wait for the positive feedback after the first communication with the inverter

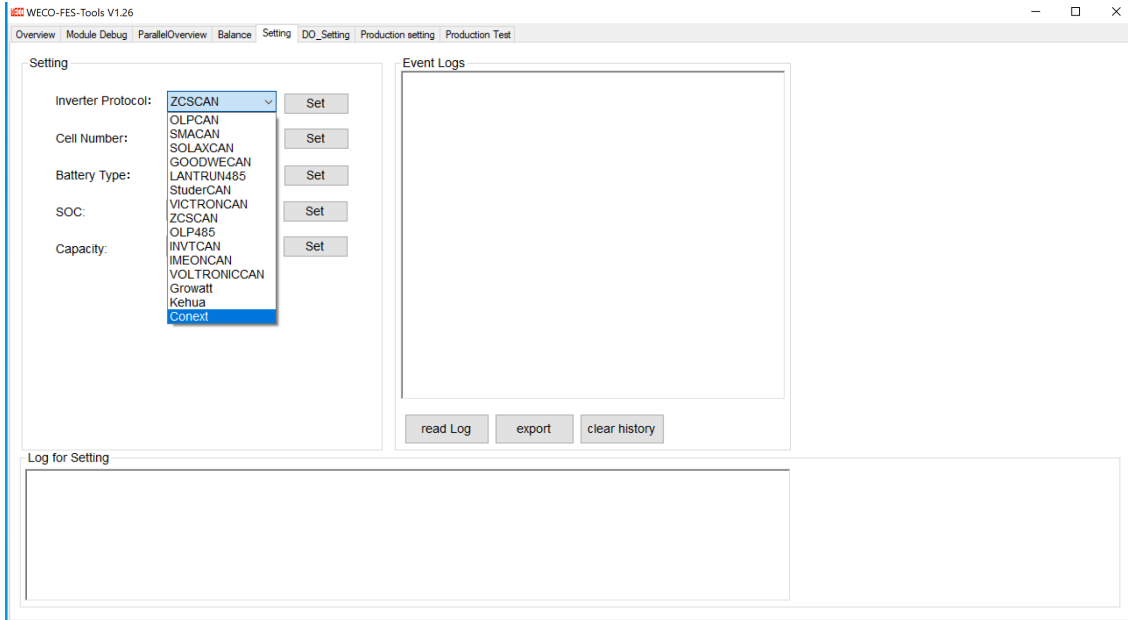

- 6. For manual adjustment to change the batteries set limits select the Operator Setting 1 TAB and change the setting in the permitted values (This operation is possible only with batteries connected to the WeCo Server (Wifi or LAN))

Setting	Setting Value	Current Value	Setting Value	Current Value
Battery Voltage High Cutoff:	52.8-60.8V	---	Charge TEMP High Cutoff:	---
Battery Voltage High Cutoff Time:	---	---	Charge TEMP High Recovery:	---
Battery Voltage High Recovery:	---	---	Charge TEMP High Cutoff Time:	---
Battery Voltage High Recovery Time:	---	---	Charge TEMP Low Cutoff:	---
Battery Voltage Low Cutoff:	---	---	Charge TEMP Low Recovery:	---
Battery Voltage Low Cutoff Time:	---	---	Charge TEMP Low Cutoff Time:	---
Cell Voltage High Cutoff:	---	---	Charge TEMP Low Recovery Time:	---
Cell Voltage High Cutoff Time:	---	---	Discharge Current High Limit Level1:	---
Cell Voltage High Recovery:	---	---	Discharge Current High Time Level1:	---
Cell Voltage High Recovery Time:	---	---	Discharge Current High Recovery Time Level1:	---
Cell Voltage Low Cutoff:	---	---	Discharge Current High Limit Level2:	---
Cell Voltage Low Cutoff Time:	---	---	Discharge Current High Time Level2:	---
Discharge TEMP High Cutoff:	---	---	Discharge Current High Recovery Time Level2:	---
Discharge TEMP High Recovery:	---	---	Charge Current High Limit:	---
Discharge TEMP High Cutoff Time:	---	---	Charge Current High Time:	---
Discharge TEMP Low Cutoff:	---	---	Charge Current High Recovery Time:	---
Discharge TEMP Low Recovery:	---	---		
Discharge TEMP Low Cutoff Time:	---	---		



7. Equalization ACTIVE PASSIVE and MANUAL, if a manual equalization is necessary after a failure, please refer to the CELL EQUALIZATION MANUAL (not public) and activate the manual procedure. **IMPORTANT**> After the first Manual/Forced Equalization the single cell equalizer will return in Auto mode within 24h



8. Factory reset. (this must be authorized from the WECO Tech Department) follow the instruction of the **FACTORY RESET PROCEDURE**

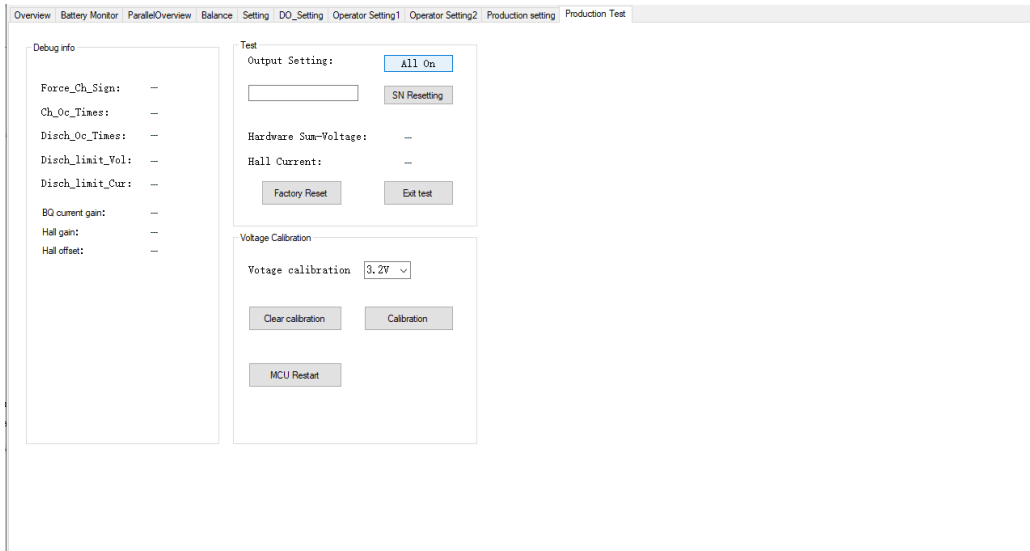



9 PRODUCT COMPATIBILITY LIST (See Also 8.5)

CAN BUS INTERFACE ACTIVE/AVAILABLE

Number	Inverter brand	Inverter model	Parallel Units	HeSU 4.4 LFP
01	SoFar / ZCS Azzurro	SP3000/HYD	5	5x4,4=22kWh x5 -- 110kWh
02	SMA	Sunny Island	5	5x4,4=22kWh x5 -- 110kWh
03	Must Solar	PH	5	5x4,4=22kWh x5 -- 110kWh
04	GOODWE	Sp-ALL LV Hybrid	5	5x4,4=22kWh x5 -- 110kWh
05	STUDER INNOTECH	Extender	5	5x4,4=22kWh x5 -- 110kWh
06	OUTBACK no BMS / Alpha CAN	ALL	5	5x4,4=22kWh x5 -- 110kWh
07	VOLTRONIC	ALL	5	5x4,4=22kWh x5 -- 110kWh
08	IMEON	ALL	5	5x4,4=22kWh x5 -- 110kWh
09	VICTRON	ALL	5	5x4,4=22kWh x5 -- 110kWh
10	INVT-MEGA	LV ALL	5	5x4,4=22kWh x5 -- 110kWh
11	Schneider ConExt	XW	5	5x4,4=22kWh x5 -- 110kWh
12	Kehua tech	Hibrid LV	5	5x4,4=22kWh x5 -- 110kWh
13	Growatt	SPH LV	5	5x4,4=22kWh x5 -- 110kWh



NO CANBUS CONNECTION AVAILABLE (INVERTER SETTINGS)

Any inverter can be used with WeCo Batteries by setting the voltage and Current Value as per Battery datasheet.

Description	Inverter Low Voltage CUT OFF	Inverter High Voltage CUT OFF	STD Charging Current (max86A -110A)	STD Discharging current (Max 86A-110A)
Single Battery	49.5 =SOC 0% Suggested 50.5= SOC 5% if ON grid Suggested 51.0 =SOC 10% if OFF GRID	54.5	65A max 110A	70A max 110A
Master + Slave1				
Master+SL1+SL2				
Master+SL1+SL2+SL3				
Master+SL1+SL2+SL3+SL4				

TEMPERATURE/ C-RATE	1C + Overload	0.5C
CHARGE	-8°C +55°C	-9°C – 15°C
DISCHARGE	-20°C +55°C	+56°C +65°C



10. SINGLE CLUSTER CONFIGURATION 100A

NO HUB IS REQUIRED FOR SINGLE CLUSTER

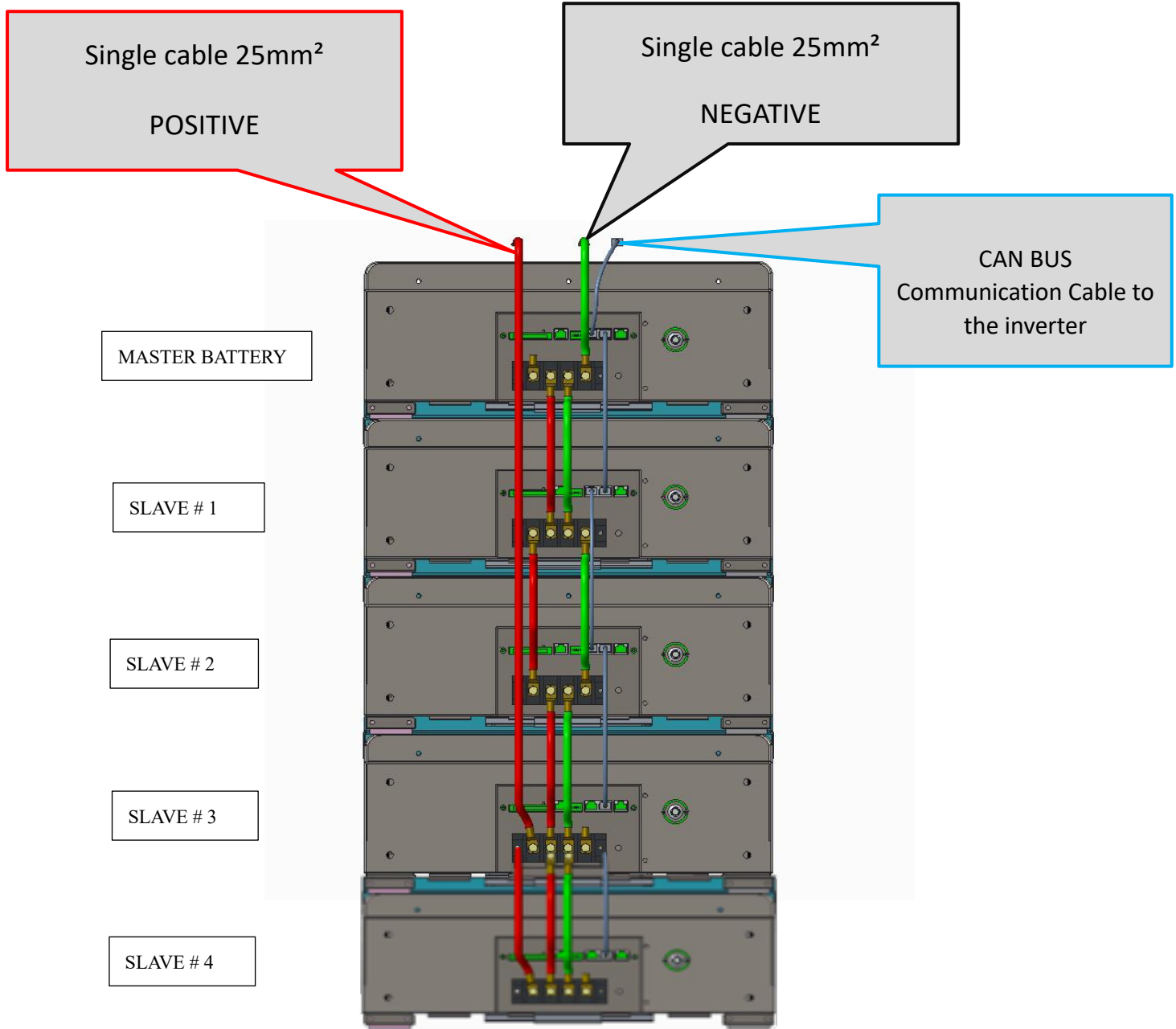

ATTENTION

**Connect two 25 mm² AWG Wire of the same length on each terminal as shown above
Strictly respect the below chart for the cluster configuration with standard kit 25 mm cables**



If more power/current is required must refer to the next paragraph

SINGLE CLUSTER CURRENT ALLOWANCE

(Standard CABLES kit connection 100A)

SINGLE CLUSTER Batteries in parallel with 25mm2 parallel connection cable	Charge/ Discharge Amps
2	86A-(110Peak)
3	86A-(110Peak)
4	86A-(110Peak)
5	86A-(110Peak)

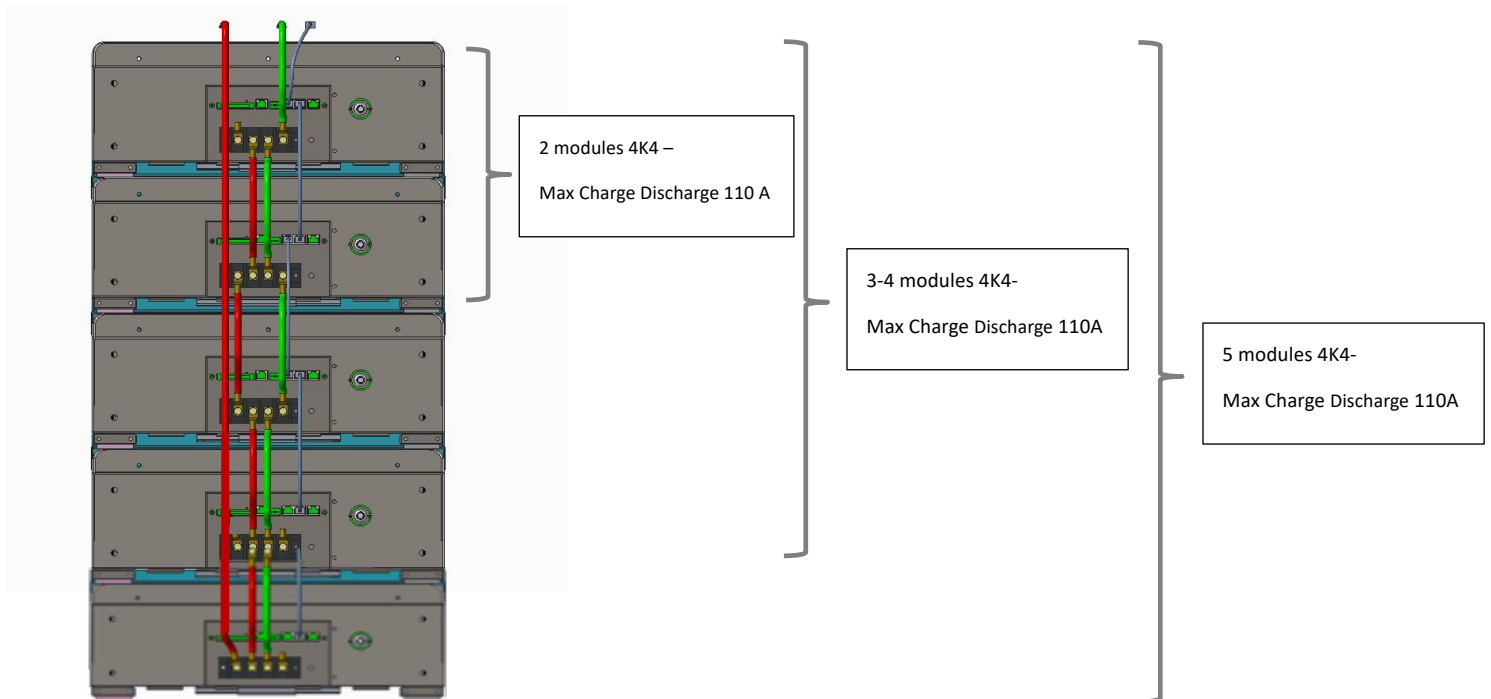



40 Nm Parallel Screw Terminal must be checked every 3 months



100A single Cluster configuration Kit

KIT ORDER CODE : STK 4K4-100-

STANDARD KIT (Order Ref. -STK 4K4-100-)		
<p>2 x cable diam. 25mm length 0,2mt terminal Ring terminal on both ends 1 x Red, 1 x Black</p>		<p>Supplied into the BRK carton Box</p>
<p>2 x cable diam. 25mm ring terminal 1 x Red 1 x Black</p>		<p>Supplied in Every Battery Carton Box</p>
UNIVERSAL BRACKET KIT (Order Ref. STK 4K4 -BRK-r19)		
<p>1 x front plate 4K4 1x Stack Brackets 1x left bracket 1x right bracket 1x back bracket 1x Screws bag 4x rubber feet</p>	<p>BRK Carton Box</p>	



11. SINGLE CLUSTER CONFIGURATION 300A

-Double BUS BAR-

NO HUB IS REQUIRED FOR SINGLE CLUSTER

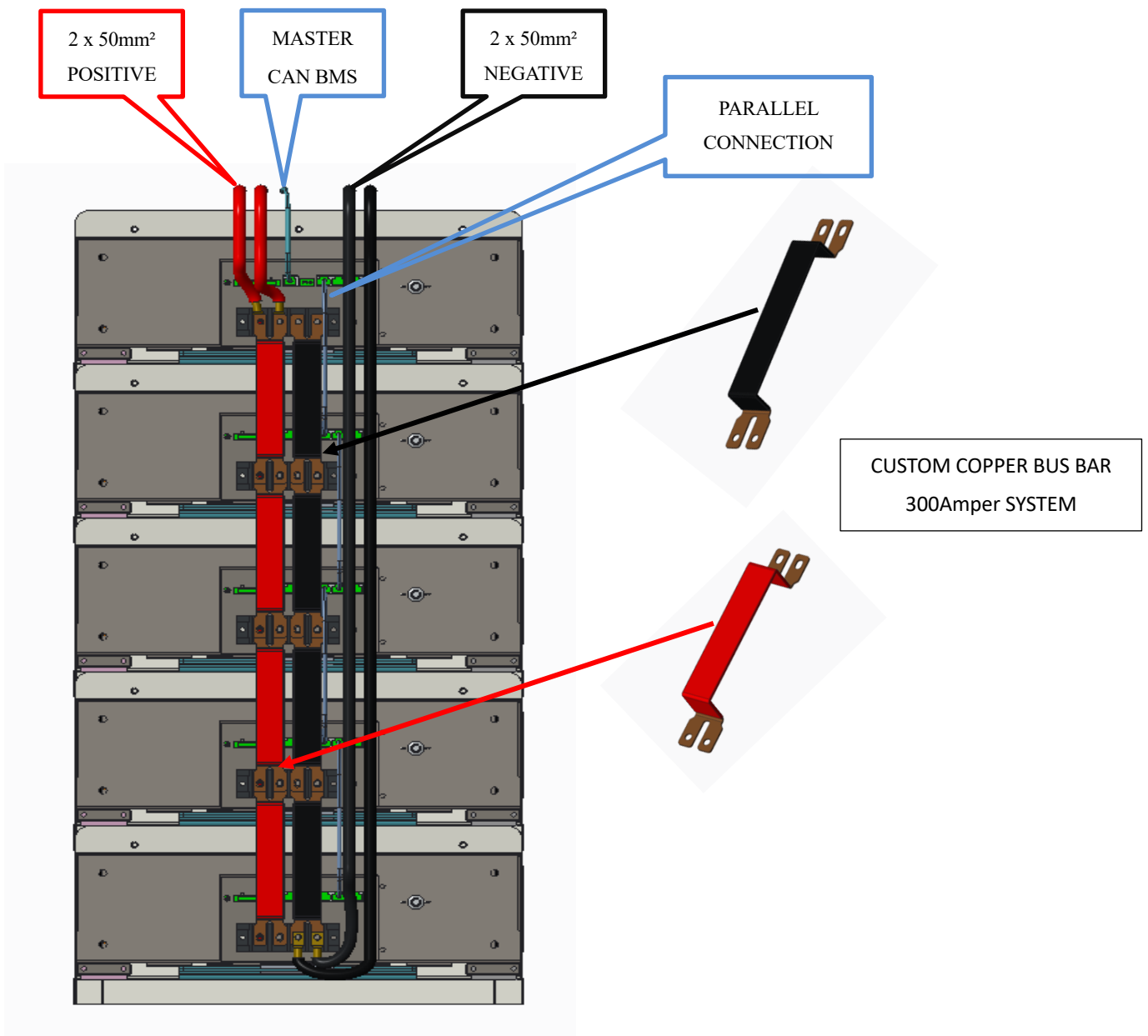



40 Nm

Parallel Screw Terminal must be checked every 3 months

SPECIAL BUS BAR FOR PARALLEL CONNECTION ABOVE 100A UP TO MAX 300A

(BUS BAR MODEL. -STK 4K4-300-)

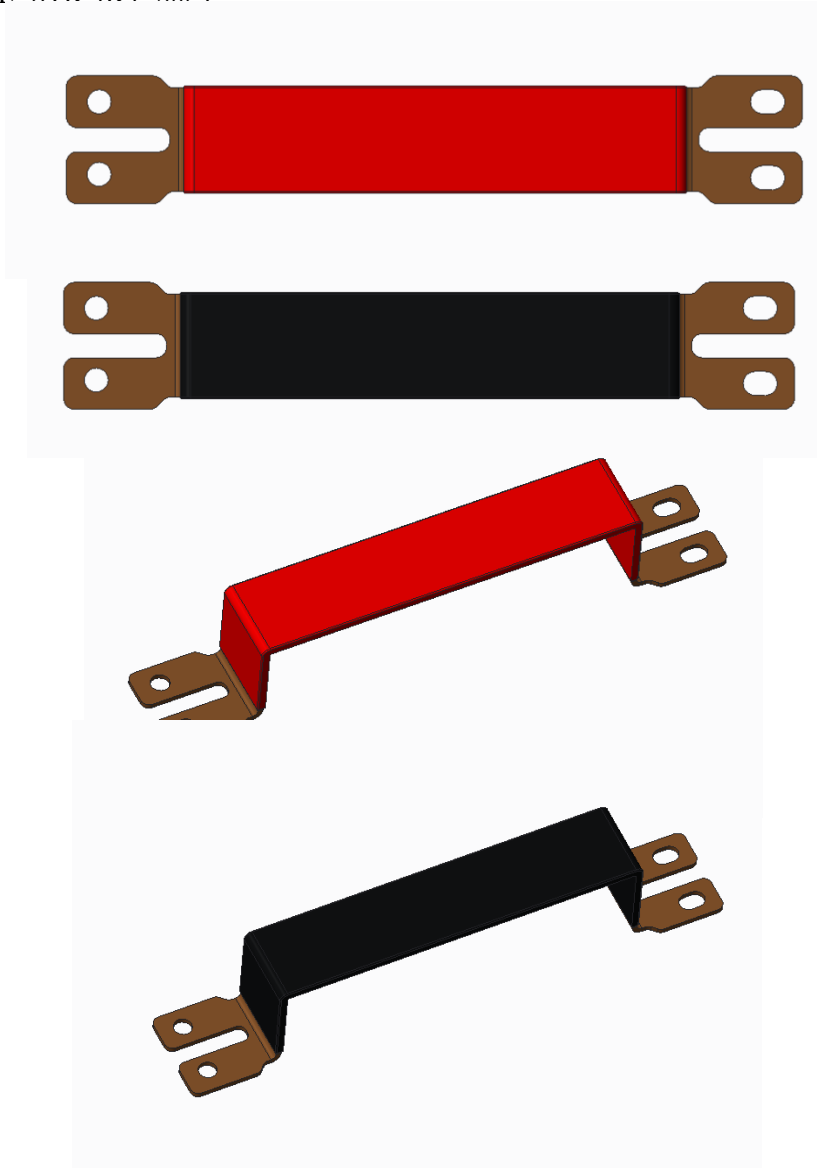





ATTENTION: BUS BAR IS MANDATORY FOR SYSTEMS ABOVE 100A

DO NOT USE DIFFERENT BUS BAR TYPES OR CABLES

300A single Cluster configuration Kit KIT ORDER CODE STK 4K4-300-

STANDARD KIT (Order Ref. -STK 4K4-300-)		
<p>1 x Custom BUS BAR Insulated RED module connection</p> <p>1 x Custom BUS BAR Insulated BLACK module connection</p>		Packed in single box
<p>2 x cable diam. 50 mm ring terminal 2 mt RED</p> <p>2 x cable diam. 50 mm ring terminal 2 mt RED</p>		
UNIVERSAL BRAKETS KIT (Order Ref. STK 4K4 -BRK-r19)		
<p>1 x front plate 4K4</p> <p>1x Stack Brackets</p> <p>1x left bracket</p> <p>1x right bracket</p> <p>1x back bracket</p> <p>1x Screws bag</p> <p>4x rubber feet</p>	BRK Carton Box	

MAIN PARALLEL BUS BARS ARE NOT PROVIDED BY WECO



12. MULTI CLUSTER HUB CONTROLLER

MULTI CLUSTER CAN HUB FOR HIGH CAPACITY AND HIGH CURRENT CONFIGURATION

REQUIRED IF MORE THAN 1 CLUSTER



BMU BMS COMBINER

We-HUB



SEE THE POWER/CURRENT CONFIGURATION BELOW
EACH BATTERY PACK AND EACH CLUSTER MUST HAVE THE SAME SOC %
ABOVE 100A MUST USE THE BUS BAR PROVIDED BY WECO (**Order Ref. -STK 4K4-300-**)
EACH CLUSTER MUST HAVE THE SAME NUMBER OF BATTERY PACKS



This BMS BMU Master Hub is mandatory when more than one cluster is connected on a common bus bar.

The WECO HUB can manage a maximum of 5 clusters composed by a maximum of 5 batteries in each cluster.

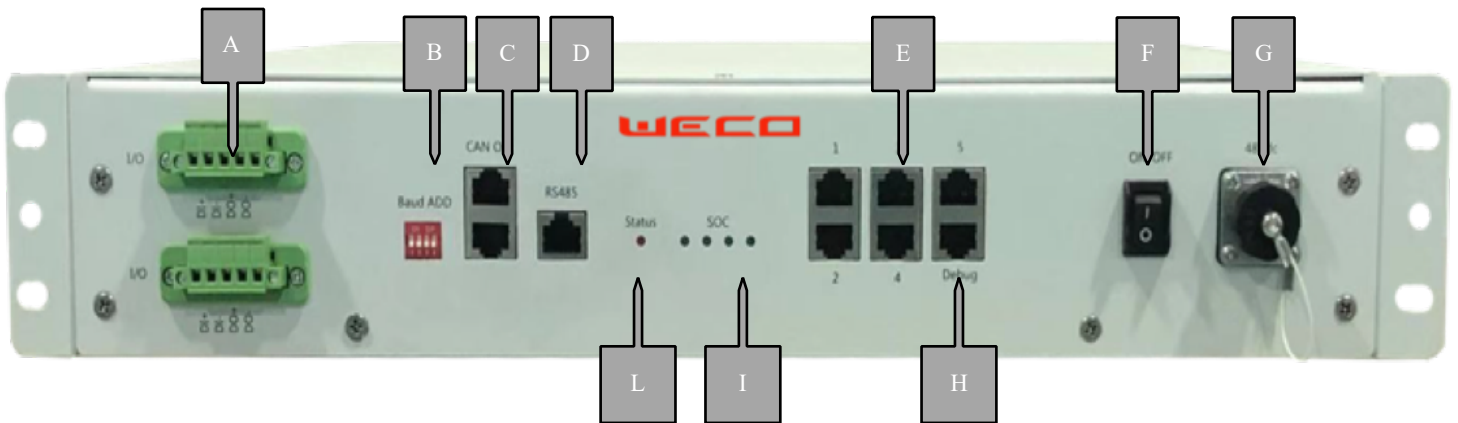

Interface description and connector		
A	I/O CONTACT 2X	Programmable closure/ contact
B	DIP SWITCH	Baud Rate Selection
C	CAN BUS PORTS 2X	CAN Bus port for external solar – grid charger
D	RS 485 port	RS 485 communication port (MODBUS)
E	CLUSTER CAN PORTS 5X	Master Cluster CAN port
F	ON OFF SWITCH	Internal Power supply switch
G	INLET 48Vdc	Connector for power input to connect to the bus bar (1A fuse protected)
H	RS232 PORT	External Port for programming and Debug
I	LED LIGHTS 4X	25% SOC status each LED
L	POWER INDICATOR	Power Supply LED Status



WECO HUB Dimensions

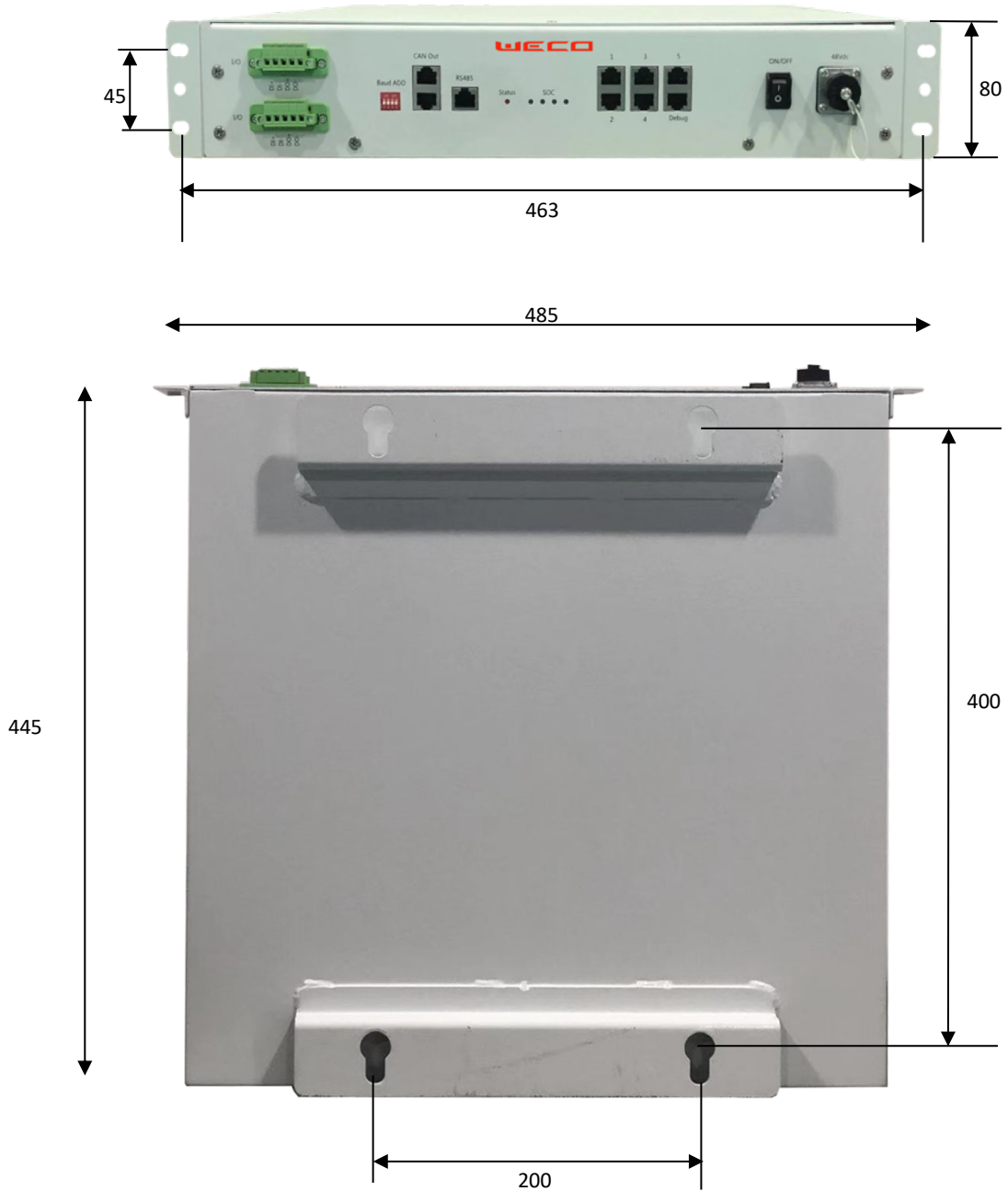



Fix on the wall with 4 x 6mm screw + washer

Weight: 8kg



KIT ORDER CODE MASTER HUB 300 LV-5

HIGH CURRENT KIT (MASTER HUB 300 LV-5)		
1 x WeHUB parallel Controller	 A rack-mountable electronic device with a white faceplate and green terminal blocks on the left. It features various ports including CAN Out, Power, and a power switch. The brand name 'WECO' is printed in red on the top right of the faceplate.	Packed in carton box
1 x WeHUB cable power supply	 A black power cable with a yellow label near the end. One end has a standard power plug, and the other end has a multi-pin connector.	



13. MULTI CLUSTER CURRENT LIMITATIONS

CONTROL LOGIC AND PROTECTION LIMIT

The inverter, if has the functions, must be set with the below restrictions in addition to the BMS control logic settings.

CURRENT SETTING / BMS CURRENT LIMIT					
Clusters Batteries	1	2	3	4	5
1	-	155	206	275	344
2	155	279	372	495	557
3	206	372	446	528	660
4	241	433	462	616	700
5	301	488	578	700	700
INVERTER LIMITS CURRENT: as per this chart	HIGH VOLTAGE 56,7 Vdc LOW VOLTAGE 48,5 Vdc				

- The charge current will be limited to 0A when the single module voltage has reached 56.8V.
- The discharge current will be limited to 0A when the single module voltage has been discharged to 46.7V.
- The battery system will communicate with the inverter to limit the current (If Inverter is Compatible).
- Each battery will be protected by the same logic separately as per single module protection concept.
- If some batteries individually will reach any fault status the single battery will protect and disconnect from the system in less than 3 seconds.
- The current limit of the system must be adjusted according to the active batteries in system in order to restore normal function.
- If the cluster is not balanced, the current limitation set from the HUB to the inverter will be sent in order to manage the rest of active modules and clusters, in the same time the imbalanced modules or cluster will equalize in standby mode and will reconnect once in the normal range.
- If more than 2 batteries in one cluster are in protection mode the entire cluster will protect by shutting down.
- If there is more than 2 cluster in protection mode, the full system will protect by shutting down.
- The batteries will send information to the inverter to limit the charge/discharge current to zero Amps if the battery is detecting an over current. (If Inverter is Compatible)
- Current limit protection cycle allows an automatic reconnection for three times. If the issue is not resolved within three reconnection attempts, it is necessary to perform a full manual restart. Precautionary checks in accordance with this manual must be carried out.
- If the current of one cluster is larger than the current limit, the battery system send a warning according with the single module BMS logic
- If the warning state does not clear within 5 minutes, the cluster will shut down and a manual reconnection is required. Precautionary checks in accordance with this manual must be carried out.



ATTENTION!

Multiple Clusters configuration is allowed only by using the specific BUS BAR for the parallel connection between various modules

The current limit is set by the WeHUB (BMU-BMS MASTER COMBINER) according with the quantity of clusters and modules connected as per the below chart

MAXIMUM CHARGE AND DISCHARGE (AMPER)

Batteries \ Clusters	1	2	3	4	5
1	-	155	206	275	344
2	155	279	372	495	557
3	206	372	446	528	660
4	241	433	462	616	700
5	301	488	578	700	700

MAXIMUM POWER CHARGE AND DISCHARGE (kW)

Batteries \ Clusters	1	2	3	4	5
1	4.8	8.7	11.6	15.4	19.3
2	8.7	15.6	20.8	27.7	31.2
3	11.6	20.8	25.0	29.6	37.0
4	13.5	24.3	25.9	34.5	39.2
5	16.9	27.3	32.4	39.2	39.2

INVERTER CHARGING DISCAHRGING CURRENT MUST BE LIMITED AS PER THE ABOVE VALUES



14. MULTI CLUSTER CONNECTION CONFIGURATIONS

GENERAL SYSTEM DESCRIPTION

WE-HUB IS MANDATORY WHEN MORE CLUSTER ARE CONNECTED IN PARALLE

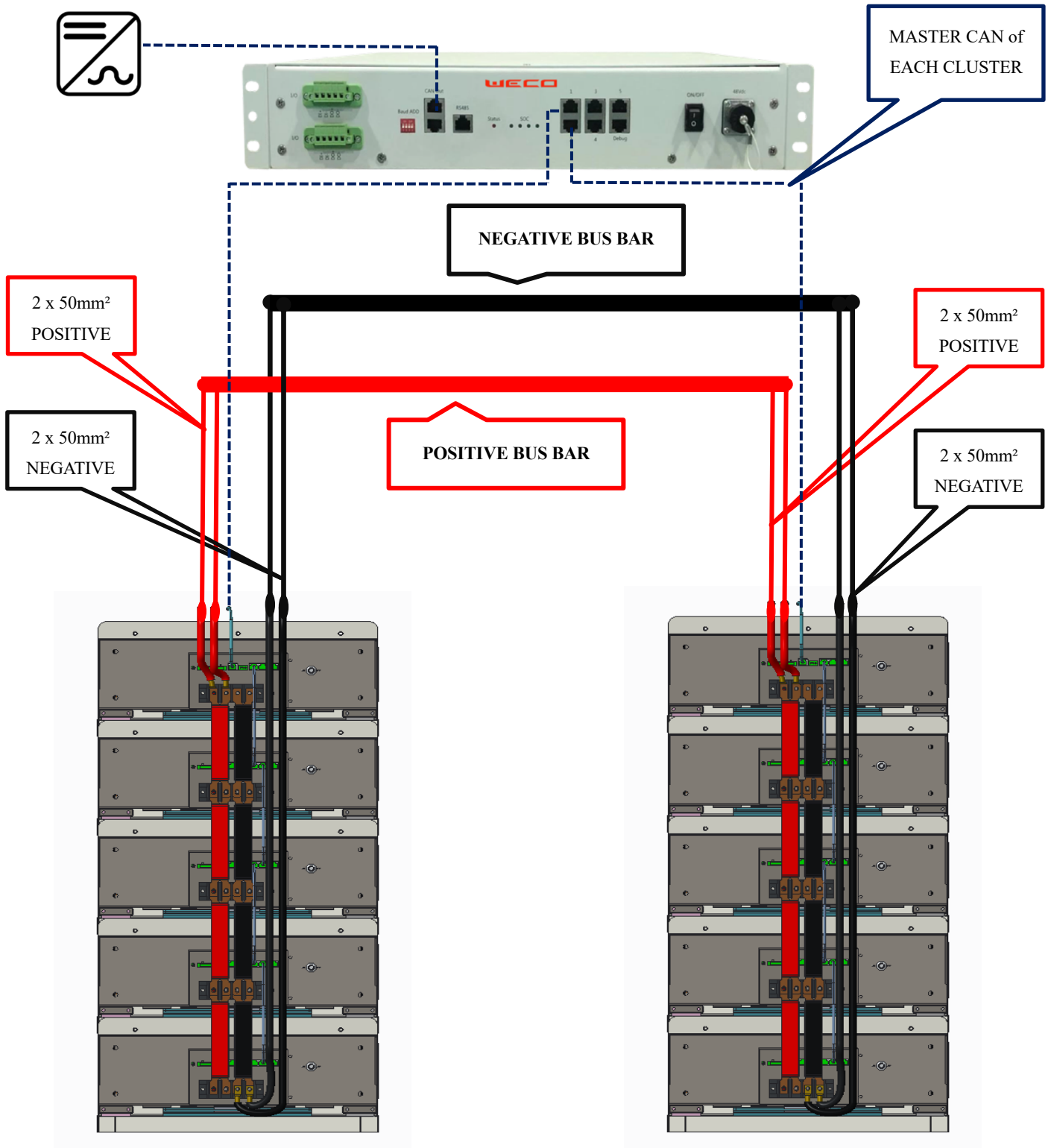



EACH BATTERY AND EACH CLUSTER MUST HAVE THE SAME SoC% and VOLTAGE



ALL THE BATTERY MODULES MUST HAVE THE SAME FIRMWARE

More Inverters (Max 300A)

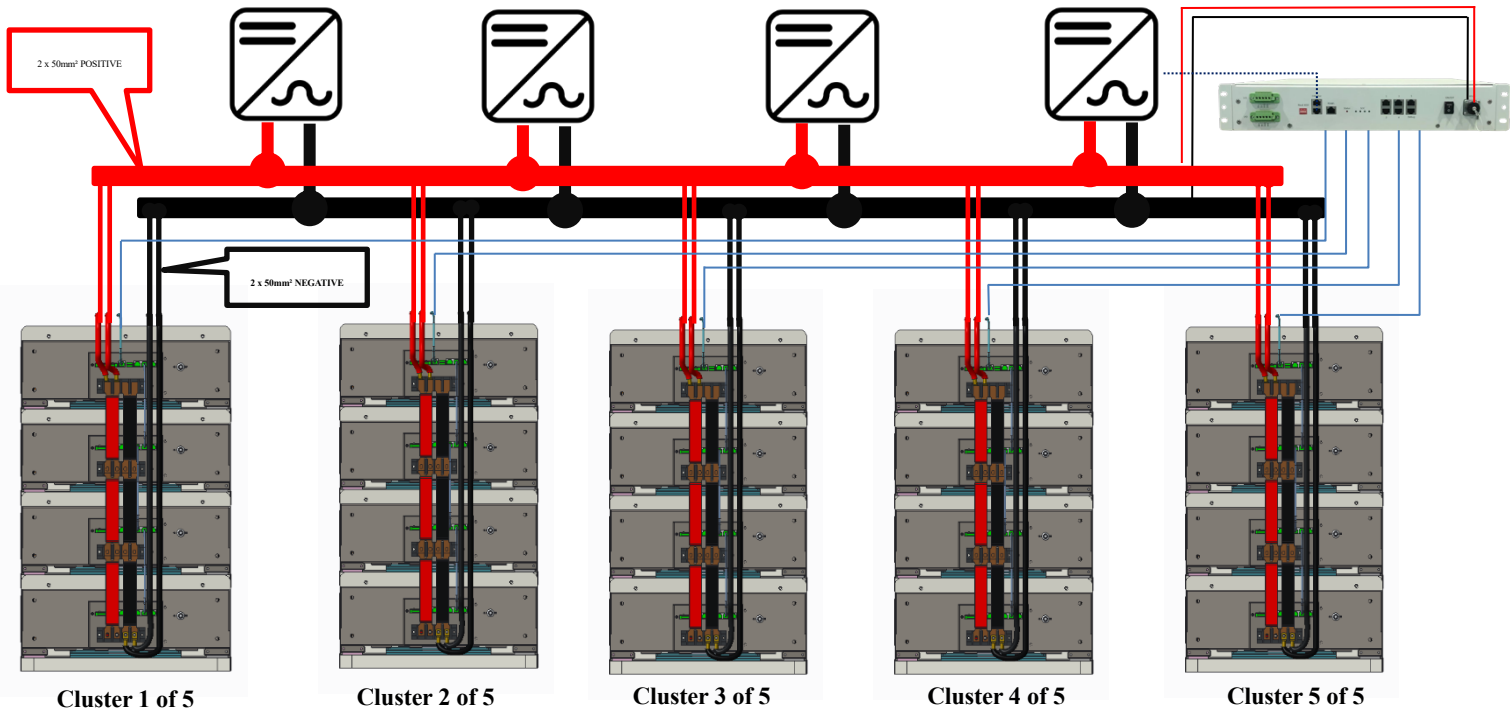
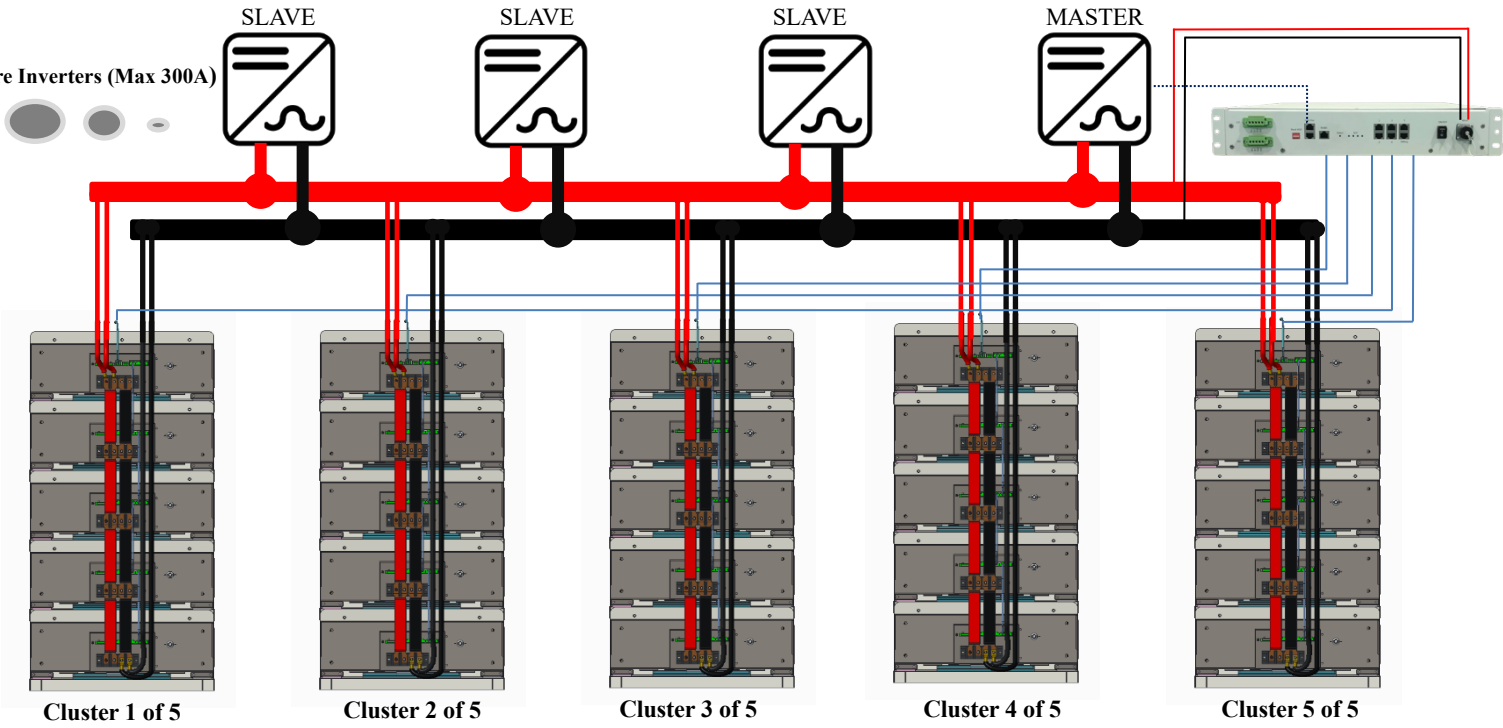



OTHER EXAMPLES OF CLUSTERS (2 and 3 Modules each)

HUB power supply

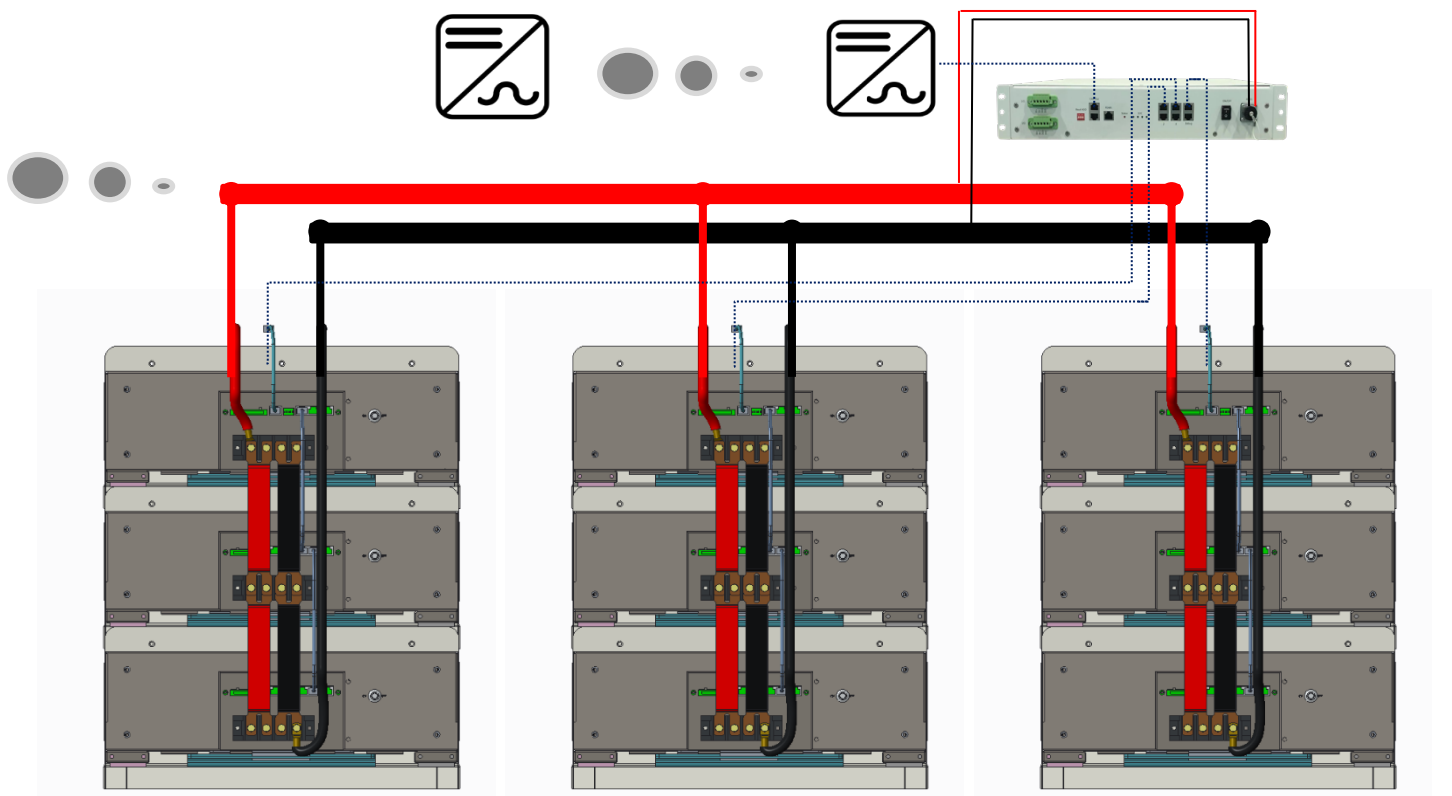
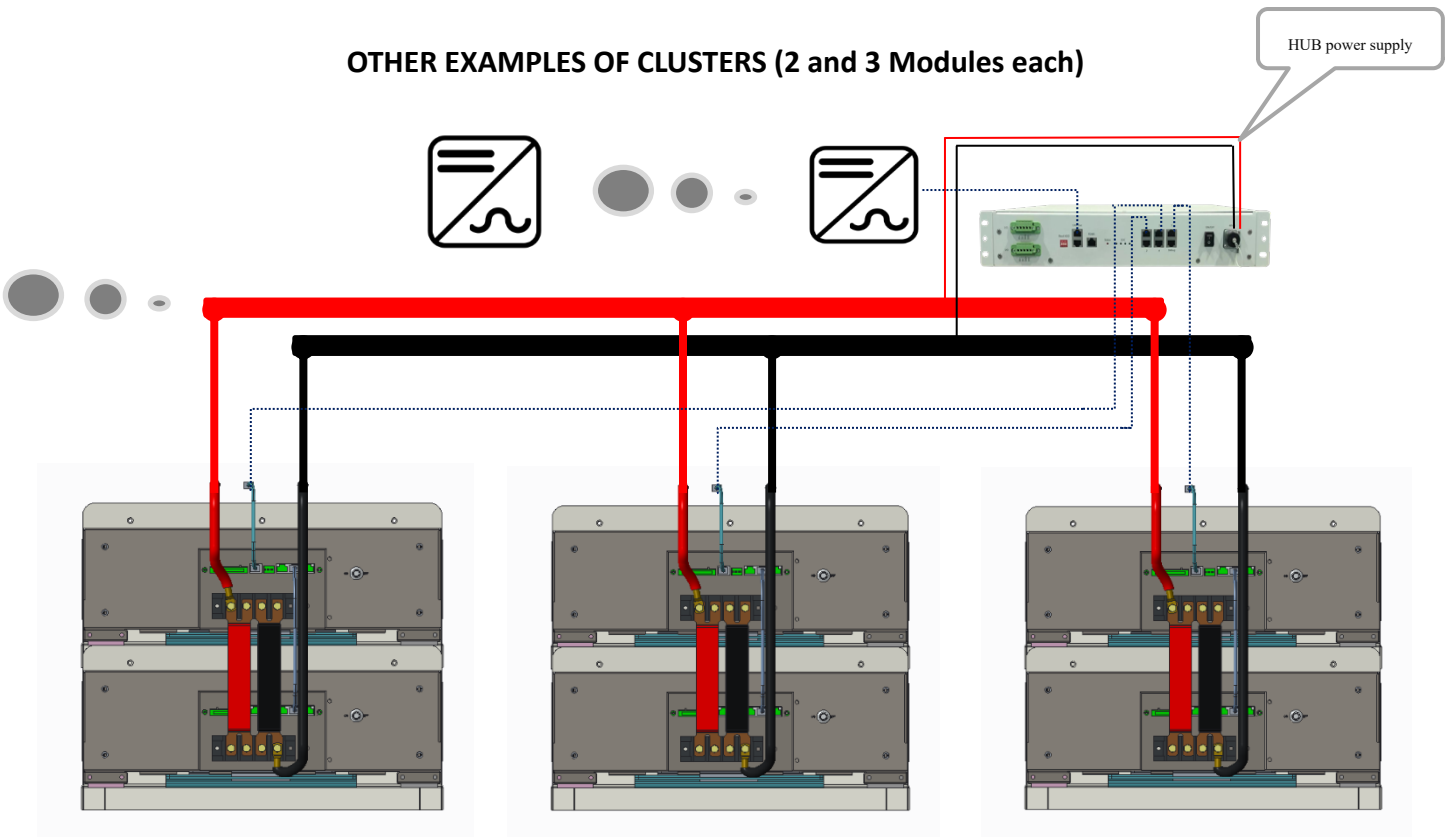



15. NO COMMUNICATION INVERTER SETTINGS (general)

FOR INVERTERS WHICH CANNOT COMMUNICATE WITH THE BATTERIES USING THE CANBUS PORT, THEY WILL NEED TO BE CAREFULLY SET IN ACCORDANCE WITH WECO BATTERY SPECIFICATIONS. THE BELOW CHART REFERS ONLY TO A SINGLE CLUSTER CONFIGURATION.

HeSU	48V
Nominal DC Voltages	52.2
Amp Hours	86
Rated kWh Capacity	4.5 kWh
Max Output Capacity	86 Ah
Max Charge Current	110 Adc
Suggested discharging Current	86Adc
DC Voltage Range (limited by contactor)	45 to 58.9 (do not use as settings)
Depth of Discharge 100%	Up to 100% (49,5V to 54,5V) max 65A
Depth of Discharge 90%	50,5V to 54,0V Max 65A
Depth of Discharge 80%	51V to 53,5V a
Operating Efficiency	98%
Operating Temp	-25° to 65°C
Charging Temp	-5° to 55°C
Self-Discharge Rate	<1% loss per month
Cycle Life	7,000+ (@ 90% DOD)
Memory Effect	None
Warranty Period	10 Years
Dimensions	46x50x16 cm
Weight	53 kg



OUTBACK INVERTER -NO COMMUNICATION-

Please contact weco@weco.uk.com, do not install inverter without BMS-CAN interface without prior approval of WeCo technical team

INVERTER	80% DoD, 10k cycles	90% DoD, 8k cycles	100% DoD, 7k
Absorb Voltage and Time	54.0 30 min	54.0, 30 min	56.8 1 hour
Float Voltage and Time	54 (default), Time = 0 = Disable		
Re-Float Voltage	50 (Disabled, leave at default)		
Re-Bulk Voltage	50.8		
AC Input Mode	Grid Tied/Support (GS8048A / GS7048E defaults, adjust as needed)		
SellRE (Offset) Voltage	54		
Low Battery Cut-Out Voltage	50 ~ 90 sec delay	48.5 ~1 sec delay	48 ~ 1 sec delay
Low Battery Cut-In Voltage	51		
CHARGE CONTROLLER			
Absorb Voltage and Time	54.0, 30 min	55.8 30 min	
Float Voltage	53,8 (Default)		
Rebulk Voltage	51		
DC Current Limit	86A _{dc} as standard per single battery (follow the manual)		
Absorb End Amps	0		
FLEXnet DC (FN-DC)			
FN-DC Battery Ah	140 / 100		
FN-DC Charge Voltage	54 Time = 15 min	55.5 Time = 15 min	
FN-DC Charged Return Amps	4A (multiply this value times the number of batteries)		
FN-DC Battery Charge Factor	98%		
FN-DC Relay Invert Logic	No		
FN-DC Relay Voltage	Default		
FN-DC Relay SOC High/Low	Default		
FN-DC Relay Delay	Default		
MATE3 AND MATE3s			
FLEXnet DC Advanced Control	Low SOC Warning = 20%		
FLEXnet DC Advanced Control	Critical SOC Warning = 10%		



OutBack Inverter and Charge Controller Setup Procedure

At the end of the charging status, near the SOC 100% the voltage may rise fast and this can be problematic, the current drops to nearly zero and the contactor may open the circuit in order to protect from overvoltage

If the charge voltage creeps up to the BMS input protection voltage (~58.5 - 59 volts), then the Charge Termination Control function can be implemented to end the charge cycle, and prevent the open circuit charging voltages to wander above the BMS input protection voltage. The settings used by Charge Termination Control are listed under the FN-DC setup on page 5.

The following steps are performed in MATE3 or MATE3s system display. Bring up the Enter Password screen using the LOCK navigation key. Enter the password 141 for the Main Menu.

Enter the inverter settings for the charger.

- From the Main Menu, select the Settings menu.
- From the Settings menu, select the Inverter menu.
- From the Inverter menu, select the Battery Charging screen. Enter the Absorb charging settings listed in Table 2.

Set the Float charging time to zero to disable it.

- Press the UP navigation key and select the AC Input and Current Limit screen. Enter the charger settings listed in Table 2. NOTE: the values listed are for maximum charge current. e. Press the UP navigation key and select the Low Battery screen. Enter the Low Battery Cut Out and Cut In voltages listed in Table 2.

Enter the inverter settings for operating modes.

- From the Main Menu, select the Settings menu.
- From the Settings menu, select the Inverter menu. c. From the Inverter menu, select the AC Input Mode and Limits screen for the appropriate input. Set Input Mode for desired operating mode. o Grid Connected Offset (AC “blending”) modes: Grid Tied, Grid Zero, Support or Mini Grid o Off-Grid modes: Backup or Generator

NOTE: More information on input modes can be found in the Radian or FXR Operator Manuals and the application notes on Offset and AC Input Modes, located at www.outbackpower.com

Enter the charge controller charger settings.

- From the Main Menu, select the Settings menu.
- From the Settings menu, select the Charge Controller menu.
- From the Charge Controller menu, select the Charger screen. Enter the Absorb and Float settings listed in Table 2.

Enter the charge controller current limits.

- Each charge controller has its own current limit from the maximum setting down to five amps. Typically the charge controller is left to the maximum setting so all available RE is accessible at all times. If for some reason the maximum current from the charge controller output needs to be limited, it can be changed from the default maximum setting on the system display using the following steps.



- From the Main Menu, select the Settings menu.
- From the Settings menu, select the Charge Controller menu.
- From the Charge Controller menu, select the Charger screen. Scroll to Current Limit and enter the setting Leave Absorb End Amps at 0.

The output power of a given charge controller is the product of the maximum output current, 110 amps in this case, and the battery voltage. Some charge controller designs employ higher PV inputs without increasing the output current, which is ineffective.

While a higher input voltage results in fewer, longer input strings, the controller will only convert that added energy if the output current is increased to match.

For example, the OutBack FLEXmax 80 was designed with an ideal input power to output power ratio.

This 80-amp charge controller will always have a maximum string configuration of three PV modules in series due to the 150 VOC input limit, and possibly only two if high power modules are used in a cold environment. It set a benchmark at its introduction to the market for many charge controllers developed since.

OutBack FLEXnet DC Setup Procedure

The FLEXnet DC Battery Monitor (FN-DC) provides three main functions:

- 1) data logging of shunt information (including daily kWh),
- 2) charge termination control
- 3) state of charge (SoC).

Charge termination control will terminate charging from all OutBack chargers (including inverters and charge controllers) when the FN-DC Battery Setup settings of Charged Voltage and Time, plus the Charged Return Amps are all met. Meeting these charge parameters is an indication that the battery is full and charging should stop.

This can save wear and tear on the batteries if multiple absorption cycles are initiated with minimal battery discharge. In this case, the charge parameters will probably be met more quickly than the Absorb time and can terminate the cycle so the batteries do not become overcharged. Meeting the charge parameters will also set the SoC to 100%.

The Charged Voltage setting is typically 0.2 Vdc lower than the lowest charger's Absorb voltage setting. This ensures the parameter is met in case there is a discrepancy between the voltmeters of the charging device and the FN-DC.

The time setting is typically about 1-3 minutes depending on the battery. Return Amps is typically 2-3% of the battery amp-hours, but use the settings in Table 2 with the WeCo batteries.

The charging current drops off more dramatically when the charging voltage is met.

The FN-DC battery function that measures amps in and out of the battery can only determine SoC after measuring against other factors. These include the Battery Ah and the Charge Factor (BCF) settings. This allows the FN-DC to determine when the battery bank is full. For example, if the batteries are 90% efficient then it would take 100 Ah plus another 10% (10 Ah) to fully recharge a 200 Ah battery bank that had been discharged 50%. In this case, the FN-DC would measure 100 Adc on the discharge, then 110 Adc on the recharge before indicating the batteries are at the point of 100% SoC.



However, a single battery only has 86 Ah, and the lowest FN-DC setting is 100 Ah.

Therefore a single battery with the FN-DC will cause SoC reading errors. Since two batteries or more will be required in most applications, it is not recommended to use single batteries with OutBack inverter systems. In addition to the single battery SoC reading error, a single battery presents a risk for overcharging. There is also a risk of inadequate power for backed up loads. More information on the FN-DC can be found in the product literature on the OutBack website under Products/SystemsManagement/FLEXnet DC, as well as an FN-DC application note under Home/Resources/Documents/Product Application Notes.

Enter the FN-DC Battery Setup settings in the system display.

- Bring up the Enter Password screen using the LOCK navigation key. Enter the password 141 for the Main Menu. Press the Settings selection from the Main Menu.
- From the Settings menu, select the Battery Monitor menu.
- From the Battery Monitor menu, select Battery Setup.
- On the Battery Setup screen, enter the TOTAL battery bank amp-hours in Battery Ah.
- Set Charged Voltage to 0.2 Vdc lower than the lowest Absorb volts setting in Table 2.
- Set Charged Return Amps to the value in Table 2.
- Set Time to 1 minute.

Enter the Charge Factor as the battery efficiency. This number is 98% for the LFP batteries.

NOTE: Charge Termination Control is enabled by default in the FLEXnet DC Advanced Control menu. There is no need to change the setting unless for some reason this function needs to be disabled. If the Grid Tied function is being used to sell back to the grid, it is possible the battery bank may never see an absorption cycle completed. This is because the inverter's Sell RE set point is never exceeded when the charge controller is on during the day. For applications utilizing offset and the Sell RE set point, there is a function under the FLEXnet DC Advanced Control settings called Enable Auto Grid-Tie Control. Changing from the default of N(o) to Y(es) will disable the Grid Tied mode at midnight and not re-enable it until the batteries have been allowed to go through an absorption cycle if necessary.



NON COMMUNICATION INVERTER SETTINGS

WeCO HeSU has a special Chemical Lithium Iron Phosphate.

After the charging period the total voltage may drop from 54/55 V to 53/52V, this is a normal behavior.

Do not insist with continuous recharge once the High Voltage or Cut Off (SOC 100%) has been reached.

In case of single cell overvoltage, the relay will open the circuit and the inverter will shut down

In this case press the RUN button and shut down the battery,

The BMS allow a self restart 4 times every 4 minutes.

In case the current or voltage limit has been passed for 4 time consecutively the operator must wait 30 minutes before press RUN once again.

A reduction of the charging current and new set up of the voltage is mandatory.

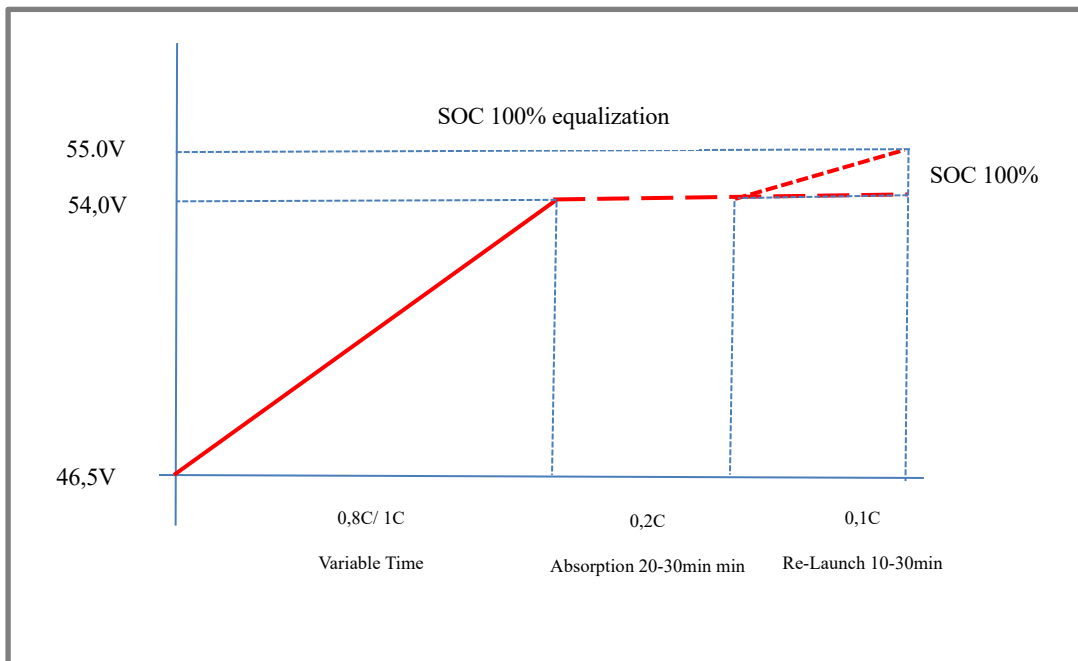

Please contact weco@weco.uk.com, do not install inverter without BMS-CAN interface without prior approval of WeCo

Single Cell Curve

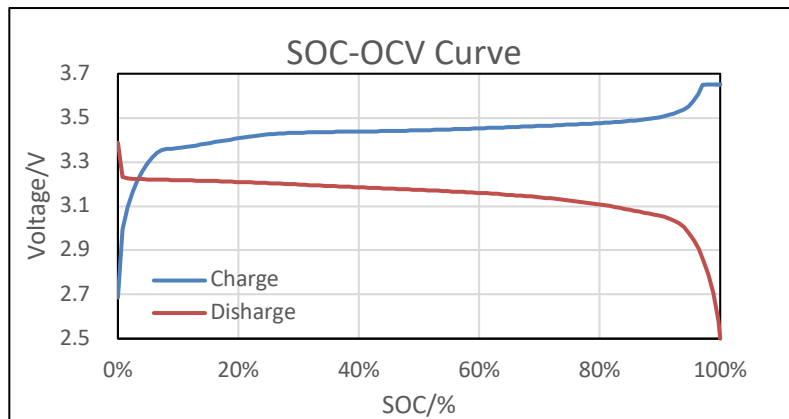



The charge and discharge current of the inverter MUST be limited according with the maximum current allowed by each cluster configuration

The charge and discharge Voltage range of the inverter MUST be limited as per the module maximum value

Please contact weco@weco.uk.com, do not install inverter without BMS-CAN interface without prior approval of WeCo technical team

NOTE:

This manual is subjected to continuous implementation.

Before install your WeCo batteries please contact our assistance team in order to have the latest manual and any additional support.

Safety improvement is our priority, please cooperate with us to improve the system, any suggestion is well accepted.

WeCo Italia Srl

WeCo FZE United Arab Emirates